

Acer Aspire 1400 Series

Service Guide

Service guide files and updates are available on the ACER/CSD web; for more information, please refer to <http://csd.acer.com.tw>

PART NO.: VD.A02V5.001

PRINTED IN TAIWAN

Revision History

Please refer to the table below for the updates made on Aspire 1400 service guide.

Date	Chapter	Updates
2002/04/11	Ch. 6	Add exploded diagram to Ch.6
2002/04/16	Ch. 3	disassembly flow chart
2002/04/19	Ch. 3	disassembly flow chart
2002/05/13	Ch. 1	p.26 Memory combinations table
2004/01/08	Ch. 1	Revise supported memory size to 512MB instead of 1GB on page 3 and page 26.

Copyright

Copyright © 1999 by Acer Incorporated. All rights reserved. No part of this publication may be reproduced, transmitted, transcribed, stored in a retrieval system, or translated into any language or computer language, in any form or by any means, electronic, mechanical, magnetic, optical, chemical, manual or otherwise, without the prior written permission of Acer Incorporated.

Disclaimer

The information in this guide is subject to change without notice.

Acer Incorporated makes no representations or warranties, either expressed or implied, with respect to the contents hereof and specifically disclaims any warranties of merchantability or fitness for any particular purpose. Any Acer Incorporated software described in this manual is sold or licensed "as is". Should the programs prove defective following their purchase, the buyer (and not Acer Incorporated, its distributor, or its dealer) assumes the entire cost of all necessary servicing, repair, and any incidental or consequential damages resulting from any defect in the software.

Acer is a registered trademark of Acer Corporation.

Intel is a registered trademark of Intel Corporation.

Pentium and Pentium II/III are trademarks of Intel Corporation.

Other brand and product names are trademarks and/or registered trademarks of their respective holders.

Conventions

The following conventions are used in this manual:

SCREEN MESSAGES	Denotes actual messages that appear on screen.
NOTE	Gives bits and pieces of additional information related to the current topic.
WARNING	Alerts you to any damage that might result from doing or not doing specific actions.
CAUTION	Gives precautionary measures to avoid possible hardware or software problems.
IMPORTANT	Reminds you to do specific actions relevant to the accomplishment of procedures.

Preface

Before using this information and the product it supports, please read the following general information.

1. This Service Guide provides you with all technical information relating to the BASIC CONFIGURATION decided for Acer's "global" product offering. To better fit local market requirements and enhance product competitiveness, your regional office MAY have decided to extend the functionality of a machine (e.g. add-on card, modem, or extra memory capability). These LOCALIZED FEATURES will NOT be covered in this generic service guide. In such cases, please contact your regional offices or the responsible personnel/channel to provide you with further technical details.
2. Please note WHEN ORDERING FRU PARTS, that you should check the most up-to-date information available on your regional web or channel. If, for whatever reason, a part number change is made, it will not be noted in the printed Service Guide. For ACER-AUTHORIZED SERVICE PROVIDERS, your Acer office may have a DIFFERENT part number code to those given in the FRU list of this printed Service Guide. You MUST use the list provided by your regional Acer office to order FRU parts for repair and service of customer machines.

Table of Contents

Chapter 1	System Specifications	3
	Features	3
	System Block Diagram	5
	Board Layout	6
	Top View	6
	Bottom View	7
	Outlook View	9
	Front View	9
	Left Panel	11
	Right Panel	12
	Rear Panel	13
	Bottom Panel	14
	Indicators	15
	Keyboard	17
	Lock Keys	17
	Embedded Numeric Keypad	18
	Windows Keys	19
	Hot Keys	20
	Keyboard Ergonomics	21
	Touchpad	22
	Touchpad Basics	22
	Launch Keys	24
	Hardware Specifications and Configurations	25
Chapter 2	System Utilities	37
	BIOS Setup Utility	37
	Navigating the BIOS Utility	37
	Main	38
	Advanced	40
	Security	42
	Others	45
	Boot	46
	Exit	47
	BIOS Phlash Utility	48
	System Diagnostic Diskette	48
	Running Diagnostic Program	49
Chapter 3	Machine Disassembly and Replacement	55
	General Information	56
	Before You Begin	56
	Disassembly Procedure Flowchart	57
	Removing the HDD Module/FDD Module/RAM Door and Optical Drive	60
	Removing the LCD Module/the Power Board and the Keyboard	61
	Removing the LCD Module	61
	Removing the Power Board and the Keyboard	61
	Disassembling the Main Unit	62
	Separate the main unit into the logic upper and the logic lower assembly	62
	Disassembling the logic upper	62
	Disassembling the logic lower	64
	Disassembling the LCD Module	66
	Disassembling the External Modules	67
	Disassembling the HDD Module	67
	Disassembling the Floppy Disk Drive Module	67
	Disassembling the Optical Drive Module	67

Table of Contents

Chapter 4	Troubleshooting	69
	System Check Procedures	70
	External Diskette Drive Check	70
	External CD-ROM Drive Check	70
	Keyboard or Auxiliary Input Device Check	71
	Memory Check	71
	Power System Check	71
	Touchpad Check	72
	Power-On Self-Test (POST) Error Message	73
	Index of Error Messages	74
	Index of Symptom-to-FRU Error Message	77
	Intermittent Problems	80
	Undetermined Problems	81
	Index of AFlash BIOS Error Message	82
	Top View	83
Chapter 5	Jumper and Connector Locations	83
	SW1 Settings (Lid switch)	84
	SW2 Settings	84
	Bottom View	85
Chapter 6	FRU (Field Replaceable Unit) List	87
	Aspire 1400	104
Appendix A	Model Definition and Configuration	105
	Main Features	105
Appendix B	Test Compatible Components	107
	Microsoft Windows XP Environment Test	108
Appendix C	Online Support Information	109
Index		111

System Specifications

Features

This computer was designed with the user in mind. Here are just a few of its many features:

Performance

- Intel® Pentium® IV processor with on-die level 2 cache
- 256 MB memory expandable to 512MB
- High-capacity, Enhanced-IDE hard disk
- Lithium-Ion battery pack
- Power management system

Display

The large graphics display offers excellent viewing, display quality and desktop-performance graphics.

- Thin-Film Transistor (TFT) liquid-crystal display (LCD) displaying 16.7 million colors at 1024X768 eXtended Graphics Array (XGA) resolution
- Video performance is boosted with 16 MB of Double Data Rate (DDR) Synchronous Dynamic Random Access Memory (SDRAM) for graphics-intensive games and applications.

Multimedia

- 16-bit high-fidelity stereo audio with 3-D sound
- Built-in dual stereo speakers
- Internal optical drive (CD-ROM, DVD-ROM, or DVD/CD-RW combo)
- Audio DJ feature
- Large LCD display with simultaneous LCD and CRT display support
- S-video (NTSC/PAL) output

Connectivity

- High-speed 56Kbps V.90 fax/data software modem
- Ethernet/Fast Ethernet (10/100 Mbps)
- Universal Serial Bus (USB) ports
- S-video (NTSC/PAL) output

Human-centric design and ergonomics

- All-in-one design (CD or DVD, floppy drive, and hard disk)
- Sleek, smooth and stylish design
- Full-sized keyboard
- Wide and curved palm rest
- Ergonomically-centered touchpad pointing device
- Launch keys (supports Audio DJ feature)
- Wireless networking (802.11b) option

Expansion

- Upgradeable memory and hard disk
- CardBus PC Card slots

Keyboard and Pointing Device

- 87 keys with 101/102 key emulation
- 1 Windows Key, 1 Application Key
- Ergonomically-centered touchpad pointing device

I/O Ports

- One 25 pins parallel port, EPP/ECP capability
- One 15 pins CRT port, Support DDC 2B
- One TV-out connector
- One MIC In port
- One headphone-out
- One DC-in jack
- One type III or two type II PCMCIA Card Bus slots
- Three 4-pins USB ports
- VR for volume control

System Block Diagram

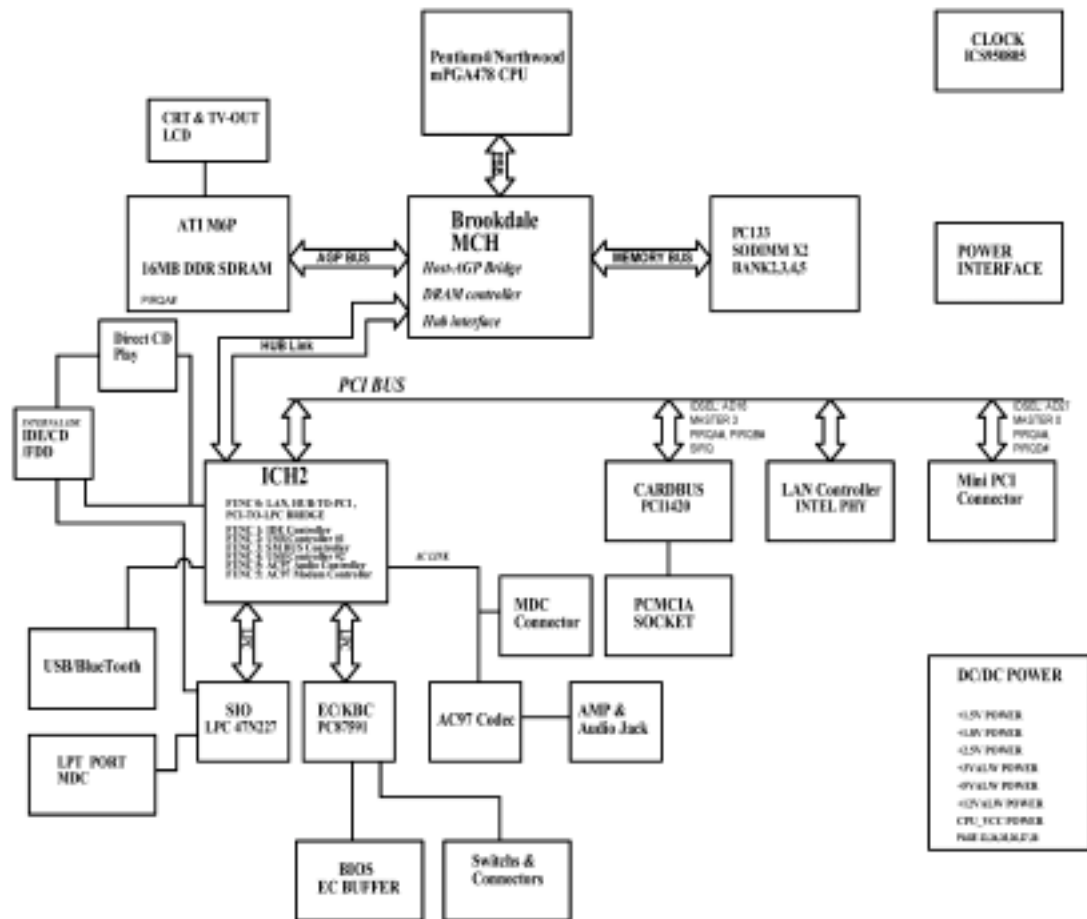

Board Layout

Top View

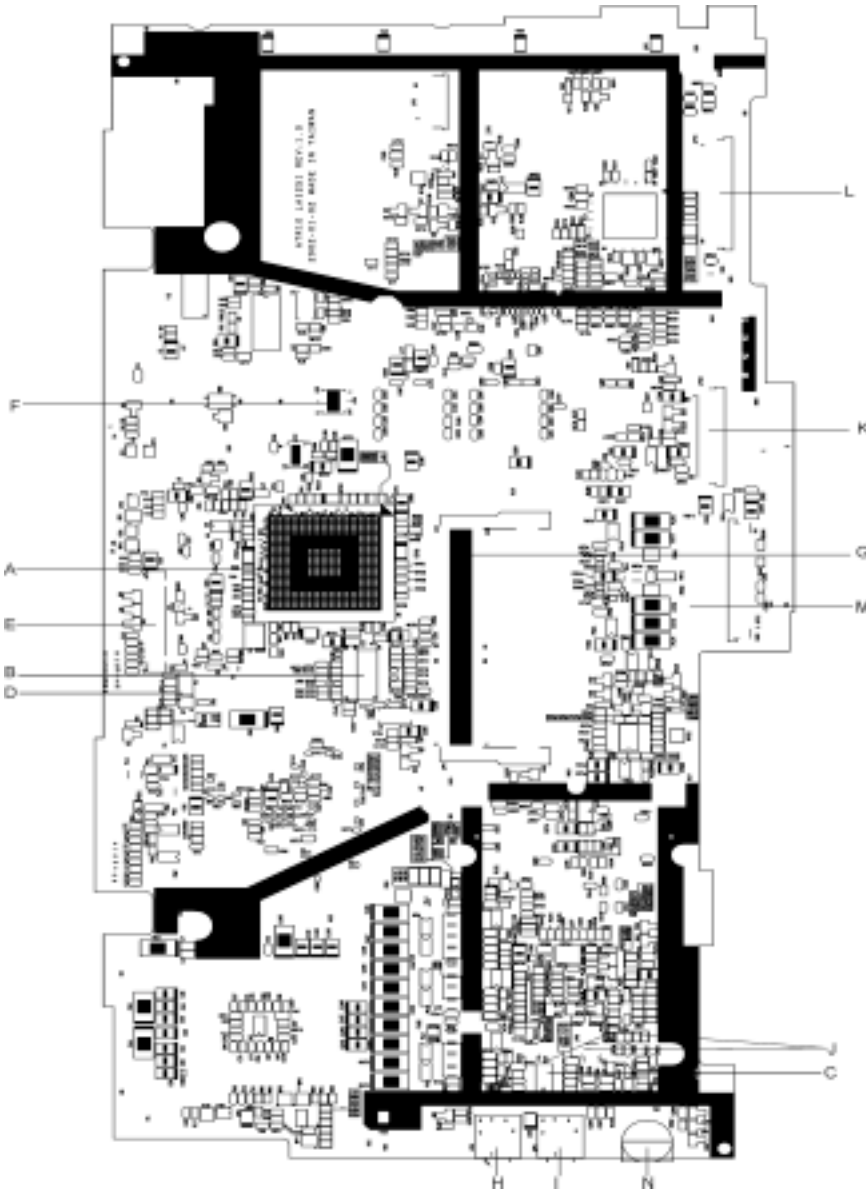

A-U8	VGA Chip ATI M6-p	B-U9	Clock Generator ICS950805AG
C-U14	Audio Amplifier Chip TDA0132	D-F1	Fuse
E-JP1	LCD Connector	F-JP2	Power Button Board Connector
G-JP5	SODIMM Connector	H-JP6	Microphone Jack
I-JP8	Earphones Jack	J-JP7, JP9	Speaker Connector
K-JP10	Main Board to Touch Pad Board FFC connector	L-JP11	Main Board to Touch Pad Board FPC Connector
M-JP12	JP12 Keyboard Connector	N-VR1	Audio Volume Control Switch

Bottom View

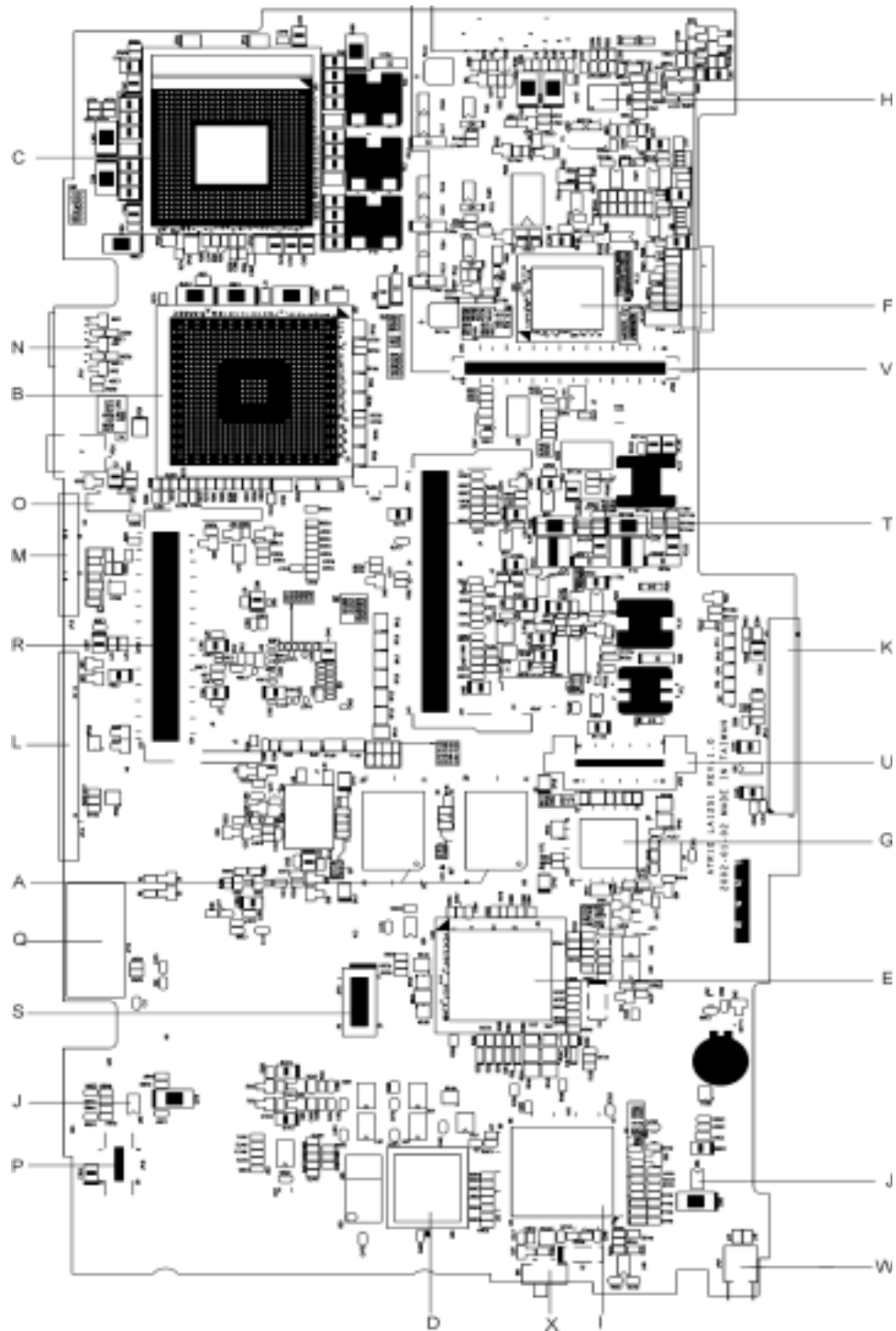



A-U10,U13	Video DDR SDRAM	B-U22	MCH Intel 845
c-U23	CPU Socket	D-U30	BIOS ROM 512K8-90
E-U33	ICH2 Intel 82801	F-U40	CARDBUS Controller PCI1420
G-U42	Direct CD-PLay Controller OZ-168T	H-U43	AC97 Codec CS-4299
I-U45	KBC/EC PC87951	J-U55,U56	USB Power Switch TPS2042DR
K-JP13	HDD Connector	L-JP14	Parallel Connector
M-JP15	CRT Connector	N-JP16	S-Video Connector
O-JP17	Fan Connector	P-JP18	M/B to USB Board Connector
Q-JP19	LAN/Modem Connector	R-JP20	MINI PCI Connector
S-JP21	MDC Module Connector	T-JP23	SODIMM Connector
U-JP25	CDROM Connector	V-JP26	PCMCIA Connector
W-JP27	USB Connector	X-SW1	Wireless LAN Switch

Outlook View

A general introduction of ports allow you to connect peripheral devices, as you would with a desktop PC.

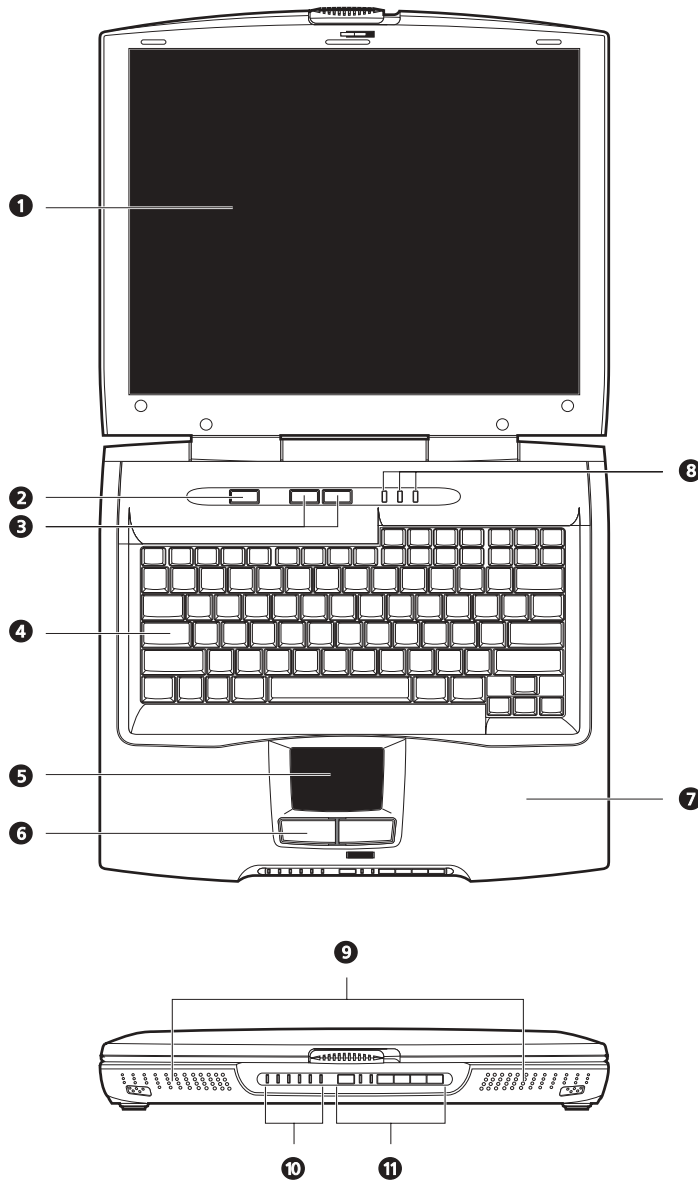
Front View





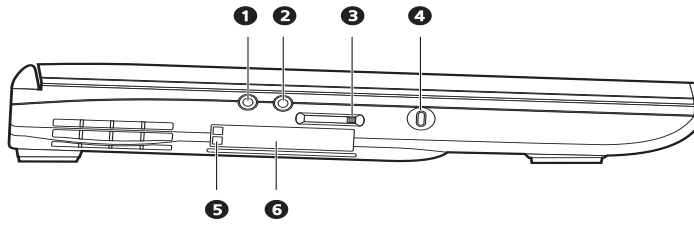

#	Icon	Item	Description
1		Display screen	Also called LCD (liquid-crystal display), displays computer output.
2		Power button	Turns on the computer power..

3		Launch keys	Buttons for launching frequently-used programs. You can launch the Internet browser and a set application with launch key.
4		Keyboard	Inputs data into your computer.
5		Touchpad	Touch-sensitive pointing device which functions like a computer mouse.
6		Click buttons (left and right)	The left and right buttons function like the left and right mouse buttons.
7		Palmrest	Comfortable support area for your hands when you use the computer.
8		Lock indicators	LEDs (light emitting diodes) that show the status of the ;lock keys.
9		Speaker	Outputs sound.
10		Status in dicators	LEDs (light emitting diodes) that show the status of the computer and its functions and components.
11		Audio DJ controls and indicators	Button and indicators for the Audio DJ function.

Left Panel



#	Icon	Item	Description
1		Speaker/headphone-out jack	Connects to audio line-out devices (e.g., speakers, headphones).
2		Microphone-in jack	Ejects the disc from the optical drive.
3		Volume control slider	Adjust the volume level.
4		Security keylock	Connects to a Kensington-compatible computer security lock.
5		PC Card eject buttons	Eject the selected PC Card from its slot.
6		PC Card slots	Accepts one Type III or two Type II/I PC Cards.



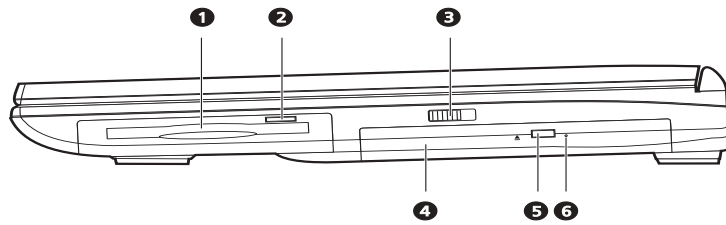



Right Panel

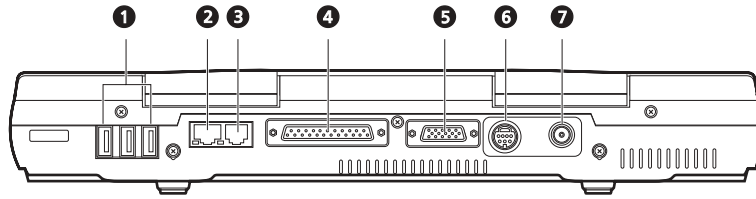

#	Icon	Item	Description
1		Floppy drive	Accepts a 3.5-inch diskette.
2		Floppy drive eject button	Press to eject the diskette from the floppy drive.
3		Wireless networking button	Enables or disables the wireless networking feature.
4		Optical drive	Depending on your model: --CD-ROM drive reads CDs. --DVD-ROM drive reads CDs and DVDs. --DVD/CD-RW combo drive reads CDs and DVDs, and writes to CD-Rs and CD-RWs.
5	▲	Optical drive eject button	Ejects the disc from the optical drive.
6		Optical drive emergency eject hole	Ejects the disc from the optical drive when the computer is turned off. There is an emergency eject hole on the optical drive. Simply insert the tip of a pen or paperclip and push to optical drive tray.

Rear Panel



#	Icon	Item	Description
1		USB ports	Connects to USB devices (e.g., USB digital camera).
2		Network jack	Connects to an Ethernet 10/100-based network.
3		Modem jack	Connects a phone line (only for models with an internal fax/data modem).
4		Parallel port Modem jack	Connects to a parallel device (e.g., parallel printer).
5		Parallel port	Connects to a display monitor.
6		External display port	Connects to a display device with S-video input.
7		DC-in jack	Connects to the AC adapter.

Bottom Panel

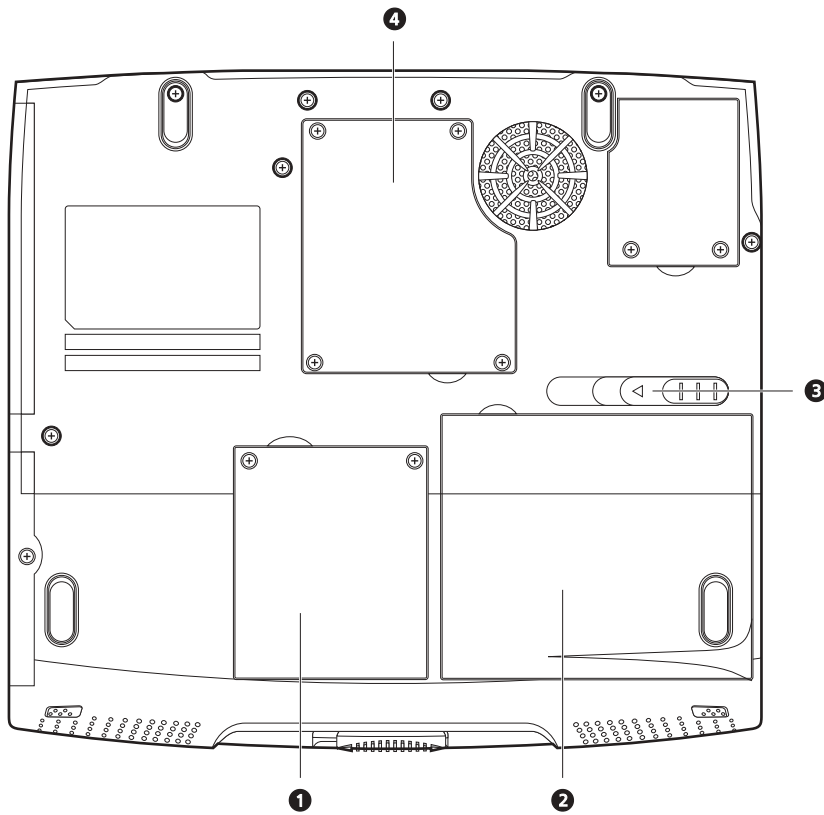





#	Icon	Item	Description
1		Hard disk bay	Houses the computer's hard disk.
2		Battery bay	Houses the computer's battery pack.
3		Battery release latch	Slide and hold to unlatch the battery pack.
4		Memory compartment	Houses the computer's memory upgrade slot.

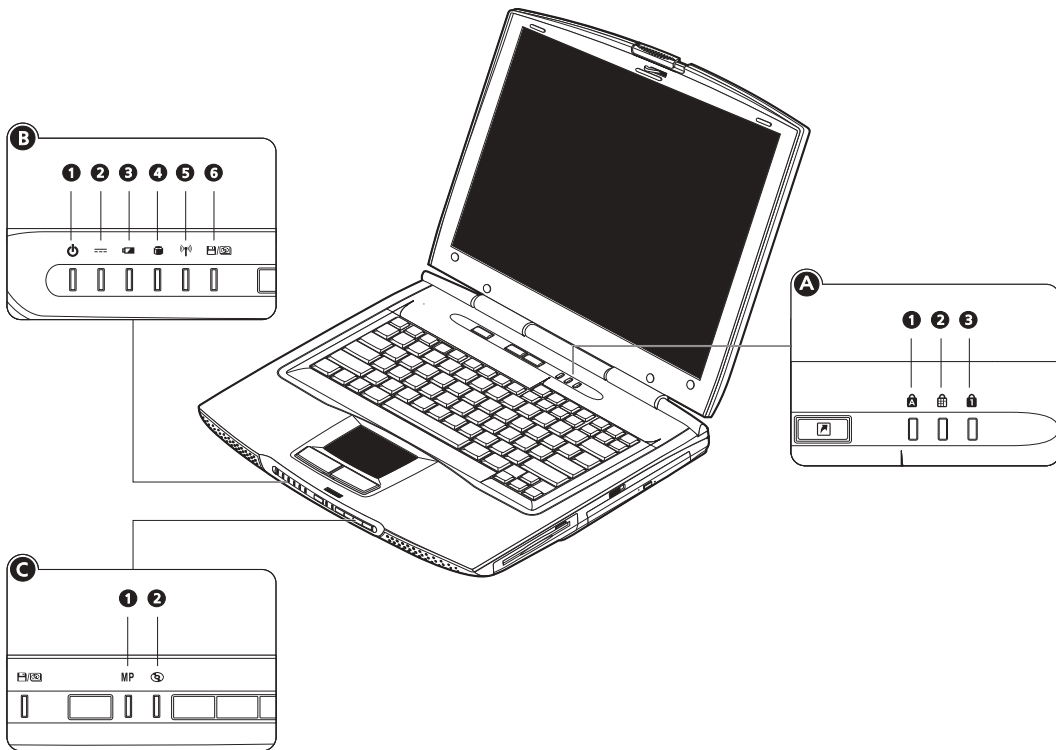



Indicators

The computer has easy-to-read lock indicators (A) found above the keyboard, and status indicators (B) and Audio DJ mode indicators (C) on the front panel of the computer.



The status LCD displays icons that show the status of the ocmputer and its components..

Icon	Function	Description
A. Lock indicators		
	Caps lock	Caps Lock is activated.
	Num lock	Numeric Lock (for embedded keypad) is activated.
	Scroll lock	Scroll Lock is activated.
B. Status indicators		
	Power	Lights when the computer is on.
	AC power	Computer is running on AC power.

Icon	Function	Description
	Battery charge	Battery is being charged.
	Hard disk activity	Hard disk is being accessed.
	Wireless networking	Wireless networking feature is enabled. Use the wireless networking switch to enable or disable this feature. See "Right view" on page 6 for the location for the location of this switch.
	Optical drive activity	Optical drive (CD or DVD) is being accessed.
C. Audio DJ mode indicators		
MP	Media Player	Audio DJ to Microsoft Media Player is set.
	CD	Audio DJ is set to CD playback.

Keyboard

Lock Keys

The keyboard has four lock keys which you can toggle on and off.

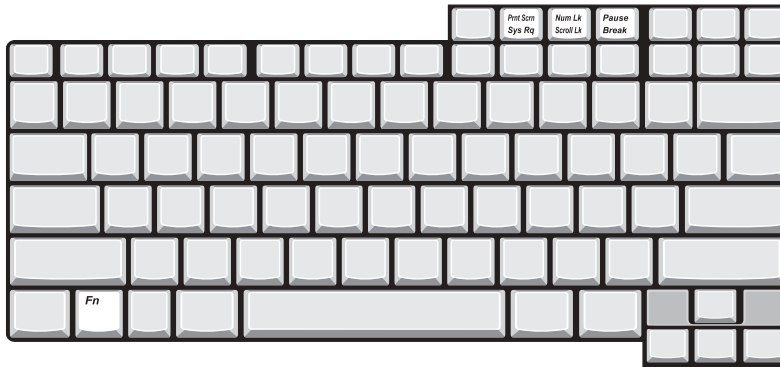

Lock Key	Description
Caps Lock	When Caps Lock is on, all alphabetic characters typed are in uppercase.
Num Lock	When Num Lock is on, the embedded keypad is in numeric mode. The keys function as a calculator (complete with the arithmetic operators +, -, *, and /). Use this mode when you need to do a lot of numeric data entry. A better solution would be to connect an external keypad.
Scroll Lock(Fn-Scroll Lk)	.When Scroll Lock is on, the screen moves one line up or down when you press <code>^v</code> and <code>^y</code> respectively. Scroll Lock does not work with some applications

Embedded Numeric Keypad

The embedded numeric keypad functions like a desktop numeric keypad. It is indicated by small characters located on the lower edge of the keycaps. The embedded keypad can function in numeric mode or cursor-control mode.

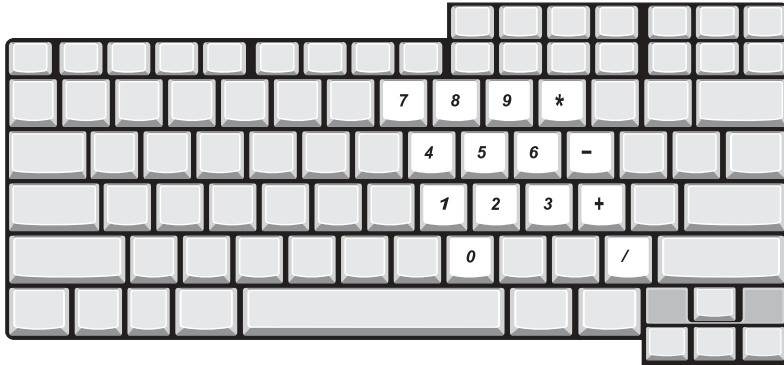

Desired Access	Num Lock On	Num Lock Off
Number keys on embedded keypad	Type numbers in a normal manner.	Hold j while typing numbers.
Cursor-control keys on embedded keypad	Hold j while using cursor-control keys.	Use cursor-control keys in a normal manner.
Main keyboard keys	Hold Fn while typing letters on embedded keypad. Also hold down j for capital letters.	Hold Fn while typing letters on embedded keypad. Also hold down j for capital letters.

Windows Keys

The keyboard has two keys that perform Windows-specific functions.

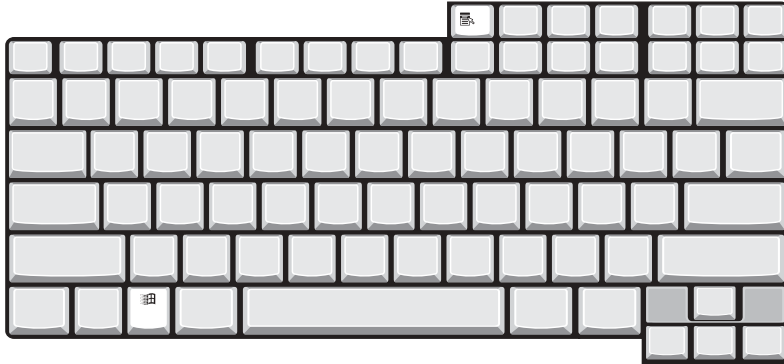

Key	Icon	Description
Windows logo key		Start button. Combinations with this key perform special functions. Below are a few examples: + Tab (Activates next taskbar button) + E (Explores My Computer) + F (Finds Document) + M (Minimizes All) j + Windows logo key + M (Undoes Minimize All) + R (Displays Run dialog box)
Application key		Opens the applications context menu (same as right-click).

Hot Keys

The computer uses hotkey or key combinations to perform functions such as controlling the screen brightness and specifying where to display output.

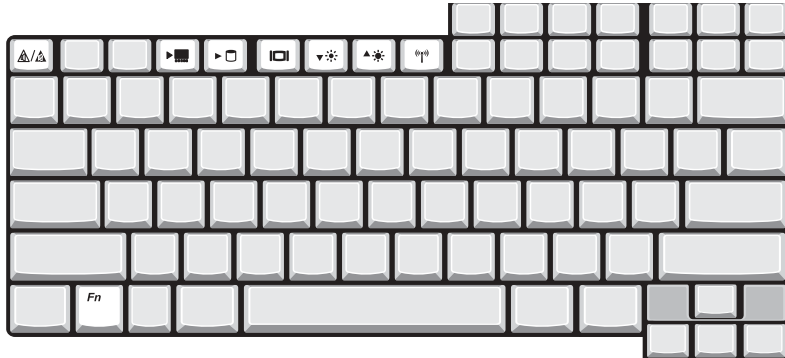

Hot Key	Icon	Function	Description
Fn-Esc		Speaker toggle	Turns the speakers on and off.
Fn-n		Standby	Puts the computer in standby mode.
Fn-o		Hibernation	Puts the computer in hibernation mode.
Fn-p		Display toggle	Switches display output between the display screen, external monitor (if connected) and both the display screen and external monitor
Fn-q		Brightness up-	Increases the screen brightness.
Fn-r		Brightness down	Decreases the screen brightness.
Fn-s		Wireless networking toggle	Toggles wireless networking on and off.

NOTE: When activating hotkeys, press and hold the Fn key before pressing the other key in the hotkey combination.

Keyboard Ergonomics

Located below the keyboard, the wide and curved palm rest is ergonomically designed to provide you with a very comfortable place to rest your hands while you type.

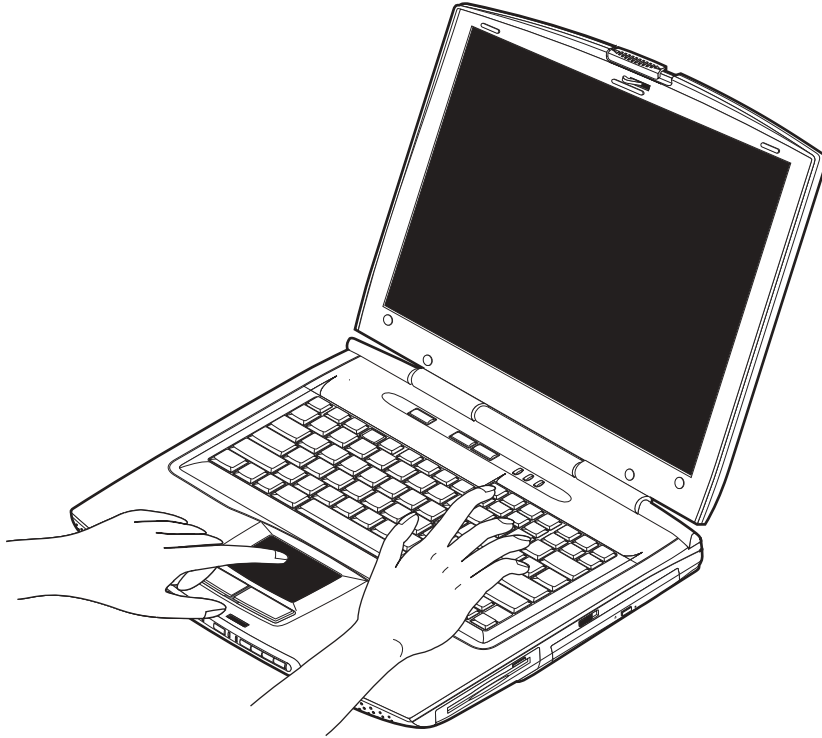

Touchpad

The built-in touchpad is a PS/2-compatible pointing device that senses movement on its surface. This means the cursor responds as you move your finger on the surface of the touchpad. The central location on the palm rest provides you optimum comfort and support.

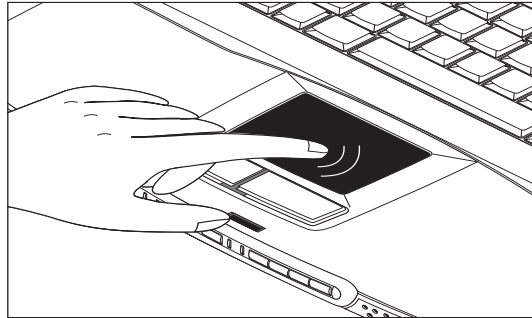

Touchpad Basics

The following teaches you how to use the touchpad:

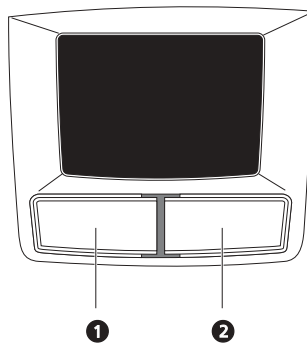

- Move your finger across the touchpad to move the cursor.
- Press the left (1) and right (2) buttons located on the edge of the touchpad to do selection and execution functions. These two buttons are similar to the left and right buttons on a mouse. Tapping on the touchpad produces similar results.

Function	Left Button	Righ Button	Tap
Execute	Click twice quickly		Tap twice (at the same speed as double-clicking the mouse button)
Select	Click once		Tap once
Drag	Click and hold, then use finger to drag the cursor on the touchpad		Tap twice (at the same speed as double-clicking a mouse button) then hold finger to the touchpad on the second tap to drag the cursor
Access context menu		Click once	

NOTE: Keep your fingers dry and clean when using the touchpad. Also keep the touchpad dry and clean. The



touchpad is sensitive to finger movements. Hence, the lighter the touch, the better the response. Tapping too hard will not increase the touchpad's responsiveness.

Launch Keys

Located above the keyboard are launch keys that can be used to launch applications.

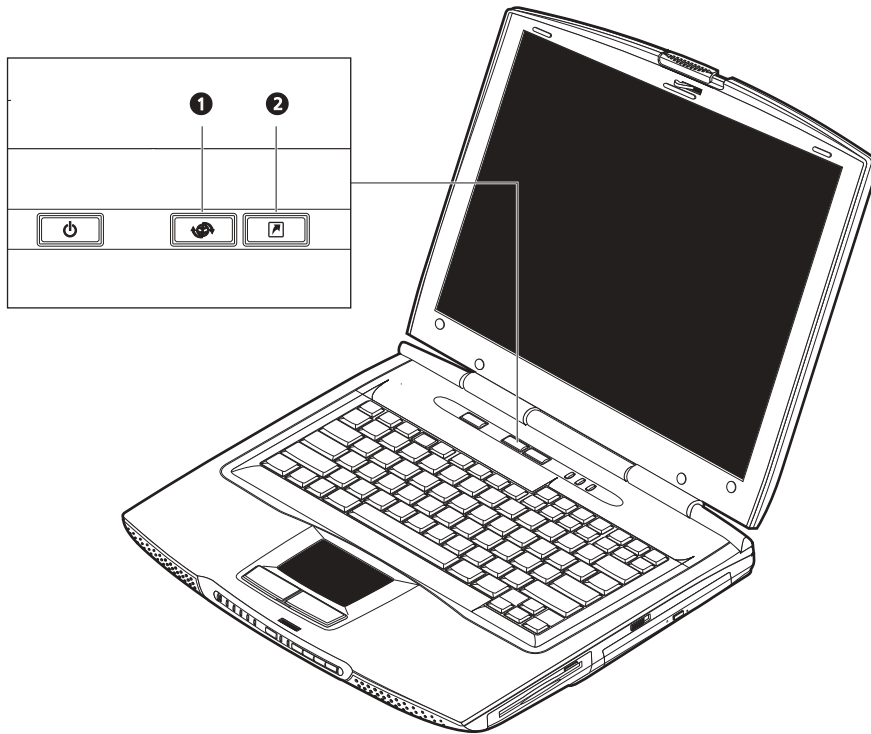
NOTE: To configure the launch keys and the applications they launch..



#	Icon	Item	Description
1		WWW	By default, launches your Internet browser.
2		Application	Launches a set application.

This computer's all-in-one design

Hardware Specifications and Configurations

Processor

Item	Specification
CPU type	Intel Desktop P4 up to 1.7GHZ or Northwood upgradable
CPU package	MPGA478 package CPU
CPU core voltage	1.75V/1.5V

BIOS

Item	Specification
BIOS vendor	Phoenix
BIOS Version	1.0
BIOS ROM type	Flash ROM
BIOS ROM size	512KB
BIOS package	TSOP
Supported protocols	ACPI 1.0b, PC Card 95, SM BIOS 2.3, EPP/IEEE 1284, ECP/IEEE 1284 1.7 & 1.9, PCI 2.2, PnP 1.0a, PS/2 keyboard and mouse, USB, VESA VGA BIOS, CD-ROM bootable,
BIOS password control	Set by setup manual

Second Level Cache

Item	Specification
Cache controller	Built-in CPU
Cache size	256KB/512KB
1st level cache control	Always enabled
2st level cache control	Always enabled
Cache scheme control	Fixed in write-back

System Memory

Item	Specification
Memory controller	Intel Brockdale (82845)
Standard memory size	128/256MB
DIMM socket number	2 sockets (2 banks). One is on the top and the other is on the button.
Supports memory size per socket	512MB
Supports maximum memory size	512MB (by two 256MB SO-DIMM module).
Supports DIMM type	Synchronous DRAM memories card
Supports DIMM Speed	133 MHz
Supports DIMM voltage	3.3V
Supports DIMM package	144-pin soDIMM
Memory module combinations	You can install memory modules in any combinations as long as they match the above specifications.

Memory Combinations

Slot 1	Slot 2	Total Memory
128MB/256 MB	0 MB	128MB/256 MB
128MB/256 MB	128 MB	256MB/384 MB
128MB/256 MB	256 MB	384MB/512 MB

NOTE: Above table lists some system memory configurations. You may combine DIMMs with various capacities to form other combinations. .

LAN Interface

Item	Specification
Supports LAN protocol	10/100 Mbps
LAN connector type	RJ45
LAN connector location	Rear side

Modem Interface

Item	Specification
Data modem data baud rate (bps)	56K
Supports modem protocol	V.90 MDC
Modem connector type	RJ11
Modem connector location	Rear side

Floppy Disk Drive Interface

Item	Specification		
Vendor & model name	Mitsumi D353G		
Floppy Disk Specifications			
Media recognition	2DD (720KB)	2HD (1.2MB, 3-mode)	2HD (1.44MB)
Sectors/track	9	15	18
Tracks	80	80	80
Rotational speed (RPM)	300	360	300
Read/write heads	2		
Encoding method	MFM/FM		
Power Requirement			
Input Voltage (V)	+5V +/- 10%		

Hard Disk Drive Interface

Item	Specification					
Vendor & Model Name	TOSHIBA 15G (MK1517)	IBM 15G (IC25N015AT D)	TOSHIBA 20G (MK2018)	IBM 20G (IC25N020AT CS)	TOSHIBA 30G (MK3018)	IBM 30G (IC25N030AT CS)
Capacity (MB)	15000	15000	20000	20000	30000	30000
Bytes per sector	512	512	512	512	512	512
Data heads	2	2	2	2	3	3
Drive Format						
Disks	1	1	1	1	2	2
Spindle speed (RPM)	4200 RPM	4200 RPM	4200RPM	4200RPM	4200RPM	4200RPM
Performance Specifications						

Hard Disk Drive Interface

Item	Specification					
Disks	1	1	1	1	2	2
Spindle speed (RPM)	4200 RPM	4200 RPM	4200RPM	4200RPM	4200RPM	4200RPM
Performance Specifications						
Buffer size	2048KB	512KB	2048KB	2048KB	2048KB	2048KB
Interface	ATA-5	ATA-5	ATA-5	ATA-5	ATA-5	ATA-5
Max. media transfer rate (disk-buffer, Mbytes/s)	216	235	287	216	235	287
Data transfer rate (host-buffer, Mbytes/s)	100 MB/Sec. Ultra DMA mode-5	100 MB/Sec. Ultra DMA mode-5	100 MB/Sec. Ultra DMA mode-5	100 MB/Sec. Ultra DMA mode-5	100 MB/Sec. Ultra DMA mode-5	100 MB/Sec. Ultra DMA mode-5
DC Power Requirements						
Voltage tolerance	5V(DC) +/- 5%	5V(DC) +/- 5%	5V(DC) +/- 5%	5V(DC) +/- 5%	5V(DC) +/- 5%	5V(DC) +/- 5%

DVD-ROM Interface

Item	Specification	
Vendor & model name	Toshiba SD-C2502	
Performance Specification	With CD Diskette	With DVD Diskette
Transfer rate (KB/sec)	Sustained: Max 3.6Mbytes/sec	Sustained: Max 10.8Mbytes/sec
Data Buffer Capacity	128 KBytes	
Interface	IDE/ATAPI	
Applicable disc format	DVD: DVD-ROM (DVD-5, DVD-9, DVD-10, DVD-18), DVD-R (read, single border) CD: CD-DA, CD+(E)G, CD-MIDI, CD-TEXT, CD-ROM, CD-ROM XA, CD-I, CD-I Bridge (Photo-CD, Video-CD) Multisession CD (Photo-CD, CD-EXTRA, CD-R, CD-RW), CD-R (read), CD-RW (read)	
Loading mechanism	Load: Manual Release: (a) Electrical Release (Release Button) (b) Release by ATAPI command (c) Emergency Release	
Power Requirement		
Input Voltage	+5 V +/- 5 % (Operating) +/- 8 % (Start up)	

Audio Interface

Item	Specification
Audio Controller	CS 4299
Audio onboard or optional	Built-in
Mono or Stereo	Stereo
Resolution	20 bit stereo Digital to analog converter 18 bit stereo Analog to Digital converter
Compatibility	Microsoft PC98/PC99, AC97 2.1
Mixed sound source	Line-in, CD, Video, AUX
Voice channel	8/16-bit, mono/stereo
Sampling rate	44.1 KHz
Internal microphone	No
Internal speaker / Quantity	Yes
Supports PnP DMA channel	DMA channel 0 DMA channel 1
Supports PnP IRQ	IRQ3, IRQ5, IRQ7, IRQ9, IRQ10, IRQ11

Video Interface

Item	Specification
Chip vendor	ATI
Chip name	M6-P
Chip voltage	Core/3.3V
Supports ZV (Zoomed Video) port	No

Video Resolutions Mode (for both LCD and CRT)

Resolution	16 bits (High color)	32 bits (True color)
800x600	Yes	Yes
1024x768	Yes	Yes
1152x864	Yes	Yes
1280x1024	Yes	Yes
1400x1050 (SXGA+panel only)	Yes	Yes
1600x1200	Yes	Yes

Parallel Port

Item	Specification
Parallel port controller	FDC47N227
Number of parallel port	1
Location	Rear side
Connector type	25-pin D-type connector, in female type
Parallel port function control	Enable/Disable/Auto (BIOS or operating system chooses configuration) by BIOS Setup Note: Depending on your operating system, disabling an unused device may help free system resources for other devices.

Parallel Port

Item	Specification
Supports ECP/EPP/Bi-directional (PS/2 compatible)	Yes (set by BIOS setup) Note: When Mode is selected as EPP mode, "3BCh" will not be available.
Optional ECP DMA channel (in BIOS Setup)	DMA channel 1 and 3
Optional parallel port I/O address (in BIOS Setup)	3BCh, 278h, 378h
Optional parallel port IRQ (in BIOS Setup)	IRQ7, IRQ5

USB Port

Item	Specification
USB Compliancy Level	1.1
OHCI	USB 1.1
Number of USB port	3
Location	Rear side
Serial port function control	Enable/Disable by BIOS Setup

PCMCIA Port

Item	Specification
PCMCIA controller	PCI142Ø
Supports card type	Type-III/II
Number of slots	One type-III or Two type-II
Access location	Left panel
Supports ZV (Zoomed Video) port	No ZV support
Supports 32 bit CardBus	Yes (IRQ11)

System Board Major Chips

Item	Controller
System core logic	Intel ICH2
Super I/O controller	LPC 47N227
Audio controller	Crystal 4299 AC 97 codes
Video controller	ATI M6-P
Hard disk drive controller	ICH2
Keyboard controller	pc87591
RTC	ICH2

Keyboard

Item	Specification
Keyboard controller	PC87591
Keyboard vendor & model name	Chicony
Total number of keypads	87/88/89 keys with 101/102 key emulation
Windows logo key	Yes
Internal & external keyboard work simultaneously	Yes

Battery

Item	Specification
Vendor & model name	Sony
Battery Type	Li-ion
Pack capacity	57Wh
Cell voltage	3.7V/cell
Number of battery cell	12
Package configuration	4 cells in series, 3 series in parallel
Package voltage	14.8v

LCD Inverter Specification

This inverter is designed to light up the CCFL of LCD for Aspire 1400 notebook. It should be supported the following LCD panels.

No.	Supplier	Model	Type
1	LG	LP150x04	TFT, 15.0" XGA
2	Hanstar	HSD150PX11-A	TFT, 15.0" XGA
3	Unipac	UB150XN01	TFT, 15.0" XGA
4	IBM	ITUX97C	TFT, 15.0" UXGA
5	Toshiba	LTM14C506	TFT, 14.1" XGA
6	Unipac	UB141X03	TFT, 14.1" XGA
7	Hanstar	HSD141PX11-B	TFT, 14.1" XGA
8	CPT	CLAA150PA01	TFT, 15.0" SXGA+
9	Hanstar	HSD1509K11-A	TFT, 15.0" SXGA+
10	Sharp	LQ150X1LH63	TFT 15.0" XGA

There are two control signals that come from system to control lamp brightness. One signal is named DAC_BRIG, which limits current to meet LCD lamp current specification. Another one is named PWM, which adjusts lamp brightness. This inverter brightness is adjusted by PWM burst mode. The PWM burst mode is that turning on and off the lamp at rate of 150Hz. The effective brightness is a function of the duty cycle.

Features

1. Wide range 9V to 21V input voltage.
2. Brightness adjustment by PWM duty mode.

3. Automatic brightness compensation for input voltage variation.

Electrical Characteristics

No	Parameter	Symbol	Min.	Typ.	Max.	Unit	Conditions
1	Input voltage	NV_PWR	9	14.8	21	V	
2	Input current	lin	--	0.33	--	A	
3	Lamp current	IL	2.7	--	6.6	mA	*Note 1
4	Frequency	f	50	55	60KHz	KHz	* Note 2
5	Output power	Pout	--	--	4.5	W	
6	Efficiency	η	80%	--	--	--	
7	Starting voltage	Vs	1500	--	---	V	
8	Starting time	Tvs	1	--	2	Sec	
9	Dispoff#		2.8	3.3	3.6	V	Backlight on/off signal
			0	0.5	0.8	V	Low level
10	Limited lamp maximum current	DAC-BRIG	0		3.3	V	*Note 1
11	PWM signal *Note 4	INV_PWM	142	150	158	Hz	PWM signal frequency
			30	3.3	3.6	V	PWM signal amplitude
			40	--	100	%	$Duty = \frac{T_{on}}{Period}$
12	Lamp current over-shoot	I zero-PK	--	--	11	mA	Line transient (10.8V to 21V/100us) and turn on transient
13	Current Waveform factor	$\frac{I_p}{I_{rms}}$	1.27	$\sqrt{2}$	1.56	Multiple	or $\frac{I_{-p}}{I_{rms}}$ *10
14	Unbalance Rate	$\frac{I_p - I_{-p} }{I_{rms}}$	-10%	0	+10%	Multiple	

NOTE: Please pay attention to the following:

*1. Limited lamp maximum current by DAC_BRIG signal:

When DAC_BRIG voltage is 0V and INV_PWM enables (100%), lamp has max. current.

When DAC_BRIG voltage is 3.3V and INV_PWM enables (100%), lamp has min. current.

DAC_BRIG signal comes from system chipset with internal resistance of 3K Ω

*2. Inverter operating frequency should be within specification (51-59kHz) at max. and min. brightness load.

*3. INV_PWM enable implies INV_PWM signal is High level (On duty cycle is 100%). It is a square wave of 150Hz to adjust backlight brightness that is a function of PWM duty cycle. Backlight brightness is maximum value under INV_PWM at 100% and brightness is minimum under INV_PWM at 40%.

*4. The system interface signals belong to 3.3V.

*5. Please make sure open lamp output voltage should be within starting voltage specification.

*6. Inverter should pass human body safety test.

*7. Inverter should not smoke by any component open/short test.

*8. Transformer voltage stress should not be over 85% under any condition.

(turn on overshoot transient and line transient.)

*9. Audio noise should be less than 36dB at 10cm distance.

Electrical specification

No	Symbol	Min.	Typ.	Max.	Unit	Comment
1	V oper*	--	680	--	V	
	II	6.0	6.3	6.6	A	
	II	2.7	3.0	3.3	mArms	Enable= H, PWM Duty = 100%
	V		100		mArms	Enable = H, PWM Duty = 30%
	Voltage form Falling and Rising time		300		Vrms	At IL = 5.5 mArms
	f	50	55	60	kHz	*2
	η	80%	85%	--	--	

Thermal

All components on inverter board should follow below rules:

1. Component using conditions (component stress) must be within component specification including voltage rating, current rating, temperature etc.

2. Component temperature should follow below:

$\Delta T \leq 30$ degree C, at 25, 35 degree C.

Component temperature should be less than 70 degree C inside system at 35 degree C.

LCD

Item	Specification				
Vendor & model name	AU UB 141X03	Samsung LTN141XF-L05	Hannstar HSD150PXII-B	Hannstar HSD150PKII-B	IBM ITUX97C
Mechanical Specifications					
LCD display area (diagonal, inch)	14.1	14.1	15.0	15.0	15.0
Display technology	TFT	TFT	TFT	TFT	TFT
Resolution	XGA (1024x768)	XGA (1024x768)	XGA (1024x768)	SXGA+ (1400x1050)	UXGA (1600x1200)

LCD

Item	Specification				
Supports colors	262K	262K	262K	262K	262K
Optical Specification					
Brightness control	keyboard hotkey	keyboard hotkey	keyboard hotkey	keyboard hotkey	keyboard hotkey
Contrast control	No	No	No	No	No
Suspend/Standby control	Yes	Yes	Yes	Yes	Yes
Electrical Specification					
Supply voltage for LCD display (V)	3.3	3.3	3.3	3.3	3.3
Supply voltage for LCD backlight (Vrms)	690	690	690	690	690

AC Adapter

Item	Specification
Vendor & model name	ADAPTER ADP-90FB RevF90W 3 PINS
Input Requirements	
Maximum input current (A, @90Vac, full load)	1.8 A @ 90Vac 0.9 A @ 180Vac
Nominal frequency (Hz)	47 - 63
Frequency variation range (Hz)	47 - 63
Nominal voltages (Vrms)	90 - 264
Inrush current	The maximum inrush current will be less than 50A and 100A when the adapter is connected to 115Vac(60Hz) and 230Vac(50Hz) respectively.
Efficiency	It should provide an efficiency of 83% minimum, when measured at maximum load under 115V(60Hz).
Output Ratings (CV mode)	
DC output voltage	+18.8V~20.0V including the effects of line voltage variation, load current, ripple and noise
Noise + Ripple	300mvp-pmax (20MHz bandwidth) for resistor load
Output current	0 A (min.) 4.74 A (max.)
Output Ratings (CC mode)	
DC output voltage	18.8~20
Constant output	4.74A
Dynamic Output Characteristics	
Start-up time	3 sec. (@115Vac)
Hold up time	5 ms min. (@115 Vac input, full load)
Over Voltage Protection (OVP)	26 V
Short circuit protection	Output can be shorted without damage, and auto recovery
Electrostatic discharge (ESD)	15kV (at air discharge) 8kV (at contact discharge)
Dielectric Withstand Voltage	
Primary to secondary	4242 Vdc for 1 second
Leakage current	100uA at 254Vac
Regulatory Requirements	1. FCC class B requirements(USA) 2. VDE class B requirements(German) 3. VCCI classII requirements(Japan)

ACPI mode	Power Management
Mech. Off (G3)	All devices in the system are turned off completely.
Soft Off (G2/S5)	OS initiated shutdown. All devices in the system are turned off completely.
Working (G0/S0)	Individual devices such as the CPU and hard disk may be power managed in this state.
S1 Sleeping State	CPU Stop Clock VGA Standby, turn off back-light PCMCIA Standby Hard Disk Spin Down motor CD-ROM Spin Down Super I/O Power down
S3 Sleeping State	CPU set power down VGA Suspend PCMCIA Suspend Audio Suspend Hard Disk Power Down CD-ROM Power Down Super I/O Power Down
S4 Sleeping State	System Saves all system states and data onto disk prior to power off the whole system.

Environmental Requirements

Item	Specification
Temperature	
Operating	+5~+35 °C
Non-operating	-20~+65 °C
Non-operating	-20~+65 °C (storage package)
Humidity	
Operating	20% to 80% RH, non-condensing
Non-operating	20% to 90% RH, non-condensing (unpacked)
Non-operating	20% to 90% RH, non-condensing (storage package)
Vibration	
Operating (unpacked)	5~500Hz: 1.0G
Non-operating (unpacked)	50~500Hz: 2.16G

Mechanical Specification

Item	Specification
Dimensions	329mm (W) x 279mm (D) x 42.3/52.8mm(H) for 14.1 LCD model 335mm(W) x 295mm (D) x 42.3/52.8mm (H) for 15.0 inch model
Weight	7.7lbs for 14.1 inch model;8.1lbs for 15.0 inch model
I/O Ports	1 parallel port (25 pins) EPP/ECP capability, 1 CRT port (15 pins) supports DDC 2B, 1 TV-out connector, 1 microphone-in port, 1 headphone-out with SPDIF port, 1 AC adapter jack (2 pins), 1 type III or type II PCMCIA card bus slots, 3 USB ports (4 pins), 1 RJ-11/RJ-45 port
Drive Bays	One
Material	Housing: Byer FR2000 Panel : Plastic
Indicators	Easy-to-read lock indicators, Status indicators, Power LED, Audio DJ mode indicators

Mechanical Specification

Item	Specification
Switch	Power, Lid, Application/Button Lock/CD-Play, Eject/Stop Button, Play/Pause Button, Reverse Button, Forward Button, Volume Down Button, volume up button

Memory Address Map

Memory Address	Size	Function
00100000h-000F0000h	64KB	System BIOS
000CD000h-000C0000h		VGA BIOS
000C0000h-000A0000h	128 KB	Video memory (VRAM)
000A0000h-00000000h	640KB	Conventional memory

I/O Address Map

I/O Address	Function
000-00F	DMA controller-1
020-021	Interrupt controller-1
040-043	Timer 1
060, 064	Keyboard controller 38859 chip select
061	System speaker out
040B	DMA controller-1
061	System speaker
070-071	Real-time clock and NMI mask
080-08F	DMA page register
0A0-0A1	Interrupt controller-2
0C0-0DF	DMA controller-2
0F0-0FF	Numeric data processor
170-177	2nd EIDE device (CD-ROM) select
1F0-1F7	1st EIDE device (hard drive) select
220-22F	Audio
240-24F	Audio (optional)
278-27F	Parallel port 3
378,37A	Parallel port 1
3B0-3BB 3C0-3DF	Video Controller
3F0h-3F7	Standard Floppy Disk Controller
3F0-3F7	Floppy disk controller
480-48F, 4D6	DMA controller-1
4D0-4D1 CF8-CFF	PCI configuration register

IRQ Assignment Map

Interrupt Channel	Function(Hardware)
IRQ00	System timer
IRQ01	Keyboard
IRQ02	Programmable Interrupt Controller
IRQ03	Free
IRQ04	Infrared Communications Controller

IRQ Assignment Map

Interrupt Channel	Function(Hardware)
IRQ05	CardBus Controller
IRQ06	Standard Floppy Disk Controller
IRQ07	Printer Port (LPT1)
IRQ08	Real Time Clock
IRQ09	SCI IRQ used by ACPI bus
IRQ10	Free
IRQ11	Audio Controller, SMBus Controller, Carbus Controller, Intel Network Connection and Modem
IRQ12	PS/2 Mouse
IRQ13	Numeric data processor
IRQ14	Ultra ATA storage Controller Primary IDE controller
IRQ15	Ultra ATA storage Controller Secondary IDE channel (CD-ROM drive)

DMA Channel Assignment

DMA Channel	Function(Hardware)
00	Free
01	SMC IrCC
02	Standard Floppy Disk Controller
03	Free
04	DMA controller

System Utilities

BIOS Setup Utility

The BIOS Setup Utility is a hardware configuration program built into your computer's BIOS (Basic Input/Output System).

Your computer is already properly configured and optimized, and you do not need to run this utility. However, if you encounter configuration problems, you may need to run Setup. Please also refer to Chapter 4 Troubleshooting when problem arises.

To activate the BIOS Utility, press **m** during POST (when "Press <F2> to enter Setup" message is prompted on the bottom of screen).

Main	Advanced	Security	Others	Boot	Exit
					Item Specific Help
System Time:		[15:29:00]			
System Date:		[02/19/2001]			
Floppy Drive:		1.44MB, 3½"			
Hard Disk:		TOSHIBA MK2018GAP-(PM)			
Quiet Boot:		[Enabled]			
LCD Display stretch:		[Enabled]			
System Memory:		640 KB			
Extended Memory:		254 MB			
BIOS Ver.		V0.04			
F1 Help Esc Exit	↑↓ Select Item ←→ Select Menu		F5/F6 Change Values Enter Select > Sub-Menu		F9 Setup Defaults F10 Save and Exit

Navigating the BIOS Utility

There are six menu options: Main, Advanced, Security, Others, Boot and Exit.

Follow these instructions:

- To choose a menu, use the cursor left/right keys (z x).
- To choose a parameter, use the cursor up/down keys (wy).
- To change the value of a parameter, press p or q .
- A plus sign (+) indicates the item has sub-items. Press e to expand this item.
- Press ^ while you are in any of the menu options to go to the Exit menu.
- In any menu, you can load default settings by pressing t . You can also press u to save any changes made and exit the BIOS Setup Utility.

NOTE: You can change the value of a parameter if it is enclosed in square brackets. Navigation keys for a particular menu are shown on the bottom of the screen. Help for parameters are found in the Item Specific Help part of the screen. Read this carefully when making changes to parameter values.

Main

The Main screen displays a summary of your computer hardware information, and also includes basic setup parameters.

Main	Advanced	Security	Others	Boot	Exit
					Item Specific Help
System Time:		[15:29:00]			
System Date:		[02/19/2001]			
Floppy Drive:		1.44MB, 3½"			
Hard Disk:		TOSHIBA MK2018GAP-(PM)			
Quiet Boot:		[Enabled]			
LCD Display stretch:		[Enabled]			
System Memory:		640 KB			
Extended Memory:		254 MB			
BIOS Ver.		V0.04			
F1 Help Esc Exit	↑↓ Select Item ←→ Select Menu		F5/F6 Change Values Enter Select > Sub-Menu		F9 Setup Defaults F10 Save and Exit

NOTE: The screen above is for reference only. Actual values may differ.

The table below describes the parameters in this screen. Settings in **boldface** are the default and suggested parameter settings..

Parameter	Description	Format/Options
System Time	Sets the system time.	Format: HH:MM:SS (hour:minute:second)System Time.
System Date	Sets the system date.	Format MM/DD/YYYY (month/day/year) System Date
Floppy Drive	Shows floppy drive type information.	1.44MB, 3 1/2: If there exists floppy drive. Not installed: If there is no floppy drive.
Hard Disk	Shows the hard disk information with the manufacturer and model name..	
Quiet Boot	Determines the way the system boots up. Shows the high-capacity disc drive installed.	Options: Enabled or Disabled
Power on display	Determines the display device on startup.	Options: Auto-Selected or Simultaneous
LCD Display stretch	Specifies whether or not to expand the image to fill the screen	Options: Enabled or Disabled
System Memory	Reports the memory size of system base memory. The size is fixed to 640KB..	

Parameter	Description	Format/Options
Extended Memory	Reports the memory size of the extended memory with an integer in the system and 32 Bit SMI will occupy 0.5MB. Note: Extended memory size= Total memory size-1MB-0.5M.	
BIOS Ver.Product Name	Shows the system BIOS version.	

The items in this screen are important and vital information about your computer. If you experience computer problems and need to contact technical support, this data helps our service personnel know more about your computer.

Advanced

The Advanced screen contains parameters involving your hardware devices.

Main	Advanced	Security	Others	Boot	Exit
					Item Specific Help
IDE Controller:		[Both]			
FDD Controller:		[Enabled]			
Infrared Port (FIR):		[Enabled]			
Base I/O address:		[3F8 IRQ4]			
DMA channel:		[DMA 3]			
Parallel Port:		[Enabled]			
Mode:		[Bi-directional]			
Base I/O address:		[378]			
Interrupt:		[IRQ 7]			
Legacy USB Support:		[Enabled]			
F1 Help	↑↓ Select Item	F5/F6 Change Values	F9 Setup Defaults		
Esc Exit	←→ Select Menu	Enter Select > Sub-Menu	F10 Save and Exit		

The table below describes the parameters in the screen Settings in **boldface** are the default and suggested parameter settings.

Parameter	Description	Options
IDE Controller	Configures the integrated local bus IDE adapter.	Both : Enables CD-ROM and Hard Drive. Primary: Enables Hard Drive only Disabled: Disables the integrated local bus IDE adapter using options. Note : Depending on your operating system, disabling an unused device may help free system resources for other devices.
FDD controller	Enables or disables the floppy disk controller.	Enabled or Disabled
Infrared Port (FIR)	Enables or disables the system's Infrared port.	Enabled or Disabled
Base I/O address	Sets the I/O address and IRQ for Infrared port.	3F8, IRQ4/2F8, IRQ3/ 3E8, IRQ4/2E8, IRQ3
DMA Channel	Sets a DMA channel for Infrared port. This field is hidden if Mode is not FIR .	DMA3 or DMA1

Parameter	Description	Options
Parallel Port	Enables or disables the parallel port.	Enabled or Disabled Note: Depending on your operating system, disabling an unused device may help free system resources for other devices.
Mode	Sets the operation mode of the parallel port.	ECP , EPP, Bi-directional or Normal
Base I/O address	Sets the I/O address for the parallel port.	378/278/3BC Note: When Mode is selected as EPP mode , "3BC" will not be available.
Interrupt	Set the interrupt for the parallel port.	IRQ7 or IRQ5
DMA channel	Set the DMA channel for the parallel port.	DMA1/DMA0/DMA3 Note: This field is hidden if Mode is not ECP .
Legacy USB Support	Enable or disable support for Legacy Universal Serial Bus.	Enabled or Disabled

Security

The Security screen contains parameters that help safeguard and protect your computer from unauthorized use.

Main	Advanced	Security	Others	Boot	Exit
					Item Specific Help
User Password Is:		Clear			
Supervisor Password Is:		Clear			
Set User Password		[Enter]			
Set Supervisor Password		[Enter]			
Password on boot:		[Disabled]			
F1 Help	↑↓ Select Item	F5/F6 Change Values	F9 Setup Defaults		
Esc Exit	←→ Select Menu	Enter Select > Sub-Menu	F10 Save and Exit		

The table below describes the parameters in this screen. Settings in **boldface** are the default and suggested parameter settings.

Parameter	Description	Option
User Password/ Supervisor Password	Shows the setting of the user password./ supervisor password.	Clear or Set
Set User Password	Press Enter to set the user password. When set, this password protects the BIOS Setup Utility from unauthorized access.	
Set Supervisor Password	Press Enter to set the Supervisor password. When set, this password controls access to the setup utility.	
Password on boot	Allows the user to specify whether or not a password is required to boot. When enabled, the user password protects the computer from unauthorized access during boot up.	Disabled or Enabled

NOTE: When you are prompted to enter a password, you have three tries before the system halts. Don't forget your password. If you forget your password, you may have to return your notebook computer to your dealer to reset it.

Setting a Password

Follow these steps:

1. Use the `w` and `and` keys to highlight the Set User Password/Set Supervisor Password parameter and press the `e` key. The Set User Password/Set Supervisor Password box appears:

Set SuperVisor Password	
Enter New Password	[]
Confirm New Password	[]

2. Type a password in the Enter new password field. The password may consist of up to eight alphanumeric characters (A-Z, a-z, 0-9). Retype the password in the Confirm new password field.
3. If there is an old password then setup will prompt with the following window instead and a current password will be required to be entered at first.

Set Supervisor Password	
Enter current password	[]
Enter New Password	[]
Confirm New Password	[]

IMPORTANT: Be very careful when typing your password because the characters do not appear on the screen.

4. User can type password in field of enter new password, and re-enter password in field of “confirm new password” for verification.

If verification OK, the supervisor password is set complete after user press enter. User can see the following message.

Setup Notice
Changes have been saved.
[Continue]

If verification fail, then user will see the following message.

Setup Warning
Password does not match
Re-enter Password
[Continue]

5. Press `e`. After setting the password, the computer sets the User Password/Supervisor Password parameter to “Set”.
6. If desired, you can opt to enable the Password on boot parameter.
7. When you are done, press `u` to save the changes and exit the BIOS Setup Utility.

Removing a Password

Follow these steps:

1. Use the **w** and **y** keys to highlight the Set User Password parameter and press the **e** key. The Set Password box appears:

Set Password		
Enter Current Password	[]
Enter New Password	[]
Confirm New Password	[]

2. Type the current password in the Enter Current Password field and press **e**.
3. Press **e** twice **without** typing anything in the Enter New Password and Confirm New Password fields. The computer then sets the User Password parameter to "Clear".
4. When you have changed the settings, press **u** to save the changes and exit the BIOS Setup Utility.

Changing a Password

1. Use the **w** and **y** keys to highlight the Set User Password parameter and press the **e** key. The Set Password box appears:

Set Password		
Enter Current Password	[]
Enter New Password	[]
Confirm New Password	[]

2. Type the current password in the Enter Current Password field and press **e**.
3. Type a password in the Enter New Password field. Retype the password in the Confirm New Password field.
4. Press **e**. After setting the password, the computer sets the User Password parameter to "Set".
5. If desired, you can enable the Password on boot parameter.
6. When you are done, press **u** to save the changes and exit the BIOS Setup Utility.

Others

The Others screen contains various parameter settings.

Main	Advanced	Security	Others	Boot	Exit
Low Battery Alarm: [Enabled] Panel Close Alarm: [Disabled] System Beep: [Enabled]					Item Specific Help
F1 Help Esc Exit	↑↓ Select Item ←→ Select Menu		F5/F6 Change Values Enter Select > Sub-Menu		F9 Setup Defaults F10 Save and Exit

The table below describes the parameters in this screen. Settings in **boldface** are the default and suggested parameter settings.

Parameter	Description	Options
Low Battery Alarm	Determines whether or not the system will alarm when the battery power is low.	Enabled or Disabled
Panel Close Alarm	Determines whether or not the system will alarm when the display cover is closed.	Enabled or Disabled
System Beep	Determines whether or not the system will emit a beep on boot up.	Disabled or Enabled

Boot

The Boot screen allows you to set the order in which the system looks for bootable devices on startup.

Main	Advanced	Security	Others	Boot	Exit
+Removable Devices +Hard Drive CD-ROM Drive Network Boot					Item Specific Help
F1 Help Esc Exit	↑↓ Select Item ←→ Select Menu		F5/F6 Change Values Enter Select > Sub-Menu		F9 Setup Defaults F10 Save and Exit

The table below describes these devices.

Parameter	Description
Removable Devices	The computer attempts to boot from the removable device (e.g., floppy drive). If unsuccessful, the system goes to the next device in the list. The removable devices include the diskette drive in module bay, the onboard hard disk drive and the CD-ROM in module bay..
Hard Drive	The computer attempts to boot from the hard disk. If unsuccessful, the system goes to the next device in the list.
CD-ROM/DVD Drive	The computer attempts to boot from the CD or DVD drive (looks for a bootable CD or DVD.)
Network Boot	The computer attempts to boot from LAN.

NOTE: A plus (+) sign may be shown in front of a device. You can press **e** to “expand” the device and see sub-items in this category.

Exit

The Exit screen contains parameters that help safeguard and protect your computer from unauthorized use.

Main	Advanced	Security	Others	Boot	Exit
Exit Saving Changes Exit Discarding Changes Load Setup Defaults Discard Changes Save Changes					Item Specific Help
F1 Help Esc Exit	↑↓ Select Item ←→ Select Menu		F5/F6 Change Values Enter Execute Command		F9 Setup Defaults F10 Save and Exit

The table below describes the parameters in this screen.

Parameter	Description
Exit Saving Changes	Saves changes made and exits the BIOS Setup Utility (same as u).
Exit Discarding Changes	Discards changes made and exits the BIOS Setup Utility.
Load Setup Defaults	Loads default settings for all parameters (same as t).
Discard Changes	Discards changes made.
Save Changes	Save changes made.

BIOS Phlash Utility

The BIOS flash memory update is required for the following conditions:

- New versions of system programs
- New features or options
- Restore a BIOS when it becomes corrupted.

Use the Phlash utility to update the system BIOS flash ROM.

NOTE: If you do not have a crisis recovery diskette at hand, then you should create a Crisis Recovery Diskette before you use the Phlash utility.

NOTE: Do not install memory-related drivers (XMS, EMS, DPMI) when you use the Phlash.

NOTE: Please use the AC adaptor power supply when you run the Phlash utility. If the battery pack does not contain enough power to finish BIOS flash, you may not boot the system because the BIOS is not completely loaded.

Fellow the steps below to run the Phlash.

1. Prepare a bootable diskette.
2. Copy the Phlash utilities to the bootable diskette.
3. Then boot the system from the bootable diskette. The Phlash utility has auto-execution function.

System Diagnostic Diskette

IMPORTANT: ¹The diagnostics program we use for Aspire 1400 is not exactly the same as PQA (Product Quality Assurance), the diagnostic program we used to employ in other model. The system diagnostic utilities is provided by Acer Headquarters. You can utilize it as a basic diagnostic tool. To get this program, find it in the Aspire 1400 service CD kit. To better fit local service requirements, your regional office MAY have other diagnostic program. Please contact your regional offices or the responsible personnel/channel to provide you with further technical details.

NOTE: For ASSY Function Test Procedure, please prepare the following items for system components test: PIO loopback, formatted floppy diskette, CD-DISK (Test Program), Sycard (Card Bus)x2, AC-adapter, feather (to see if the fan works), TPDL server, USB_HUP, USB_barcode scanner.

¹ New added description. Please pay attention to it.

Running Diagnostic Program

1. Test program download

Insert TPDL server LAN cable to Aspire 1400 RJ-45 Jack and power on the system via network boot. Download the ASSY/PACK test program image. If you see the message below display on the screen, then the image download is complete.

```
C:\> c:
*****
      TPDL OK !!
*****
C:\> pause
Press any key to continue . . .
```

2. Parallel Port Test

Insert PIO loopback to parallel port, then run "PIO.exe" for testing.

```
**** Parallel Port Test Program !! *** V1.0 10/16/00 **

Testing LPT1 Internal Loopback: Testing patterns...FF FF [ PASS ]
Testing LPT1 External Interrupt...[ PASS ]
Testing LPT1 External Loopback...
  1. Data Pin (p2~p9) & Err Pin (p15) Test ..[ PASS ]
  2. Control Register Test ..[ PASS ]
  3. Control Pin & Status Pin Test ..[ PASS ] [ PASS ]
```

3. RTC, FDD Test

Insert diskette to floppy disk drive, then run "Compalt.exe" for t test.

```
LAP:00001(0000:01) COMPAL TSEL/F:FDD.SCY IN:2 Version:1.65
<01| RTC/CALENDAR |>
Wait for zero counter...
Testing...05:44:53
DOS TIME = 05:44:52.13(2069213), CMOS TIME = 05:44:52(2069200)
DOS DATE = 01/29/2002, CMOS DATE = 01/29/2002
DATE & TIME test Passed.

<02| FLOPPY DISK |>
Testing Driver A: [1.44 MByte (Cyl:80, Head:2, Sec:18)]...
Testing DMA transfer... Passed.
Testing Seq. seek/verify... Head: 01, Track: 79... Passed.
Testing Fun. seek/verify... Head: 01, Track: 60...
```

4. Configuration check for each SKU

Run "ACR10CFG.bat". You will see the display below. Then insert USB_Barcode scanner to input the SKU part number in order to check each SKU configuration. .

```
                Please input the SKU name : 2

CPU 1700 256 FIR. TSB-DVD ID1 NoWEP MODEM HDD 16MB 20000
```

If the configuration check has no problem, it will go to next test item. If the configuration check fails, the test program will pause and show the error configuration.

```
                Please input the SKU name : 1

CPU 1700 256 FIR. TSB-DVD ID1 NoWEP MODEM HDD 16MB 20000
WANTEDTED SPEC IS :
CPU 1700 256 FIR. TSB-DVDRM ID0 NoWEP MODEM HDD 16MB 20000
```

5. Touch pad/USB Mouse Test

Run "FATMOUSE.exe" to check the touch pad function. Then plug in USB mouse to check its functions. Move the cursor to X=0, Y=0 and click left and right buttons as the test is complete. The test program will go to next item.

```
** FATMOUSE test version 1.00 **

Please check for mouse action & status
Test end coordinate X=0 Y=0 and push left and right buttons

      Coordinate          Button
      X      Y           Left   Right
      272   136           0       0

                █
```

6. Video mode Test (LCD/CRT swithc)

Run "SS_PIXS.exe and check the R.G.B video mode display quality on LCD and CRT."

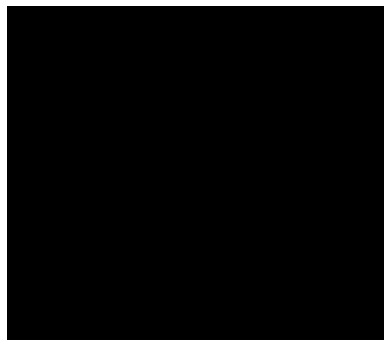
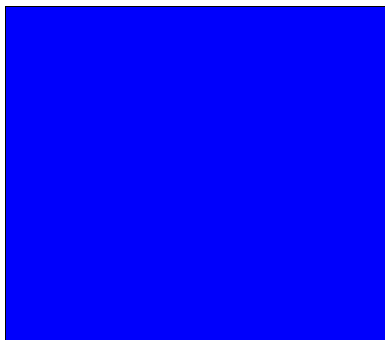
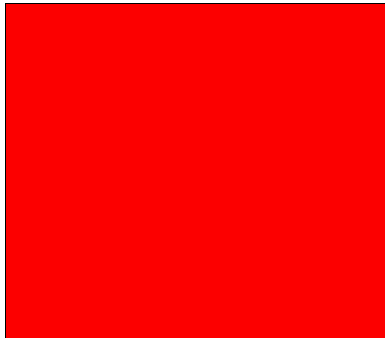
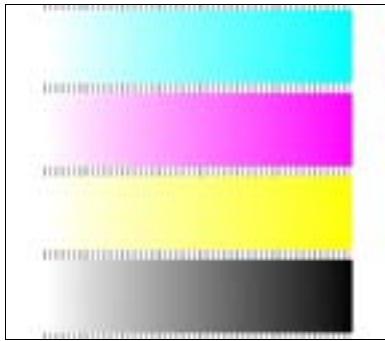

7. Direct Button Test

Run the "BUTTON.exe" to test Audio DJ controls.

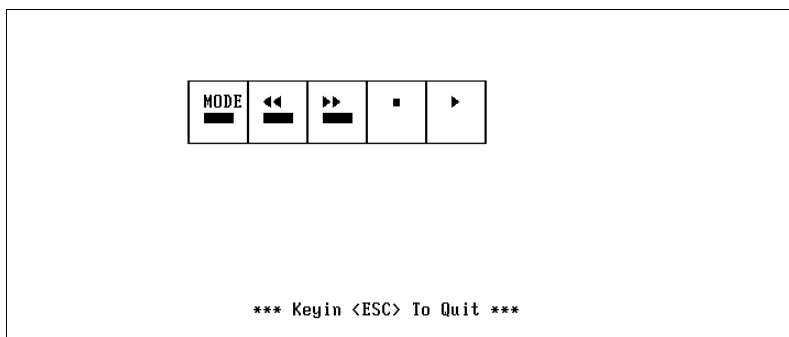

8. FAN ON/OFF Test

Run the "TEST42.exe". You may put a feather in front the fan to see if the fan works or not.



9. CD-ROM and Audio Test

Insert test CD to CD-ROM drive. Then run "Compalt.exe" to check CD-ROM function. If you hear sounds from left/right speakers, press "p" to next item.

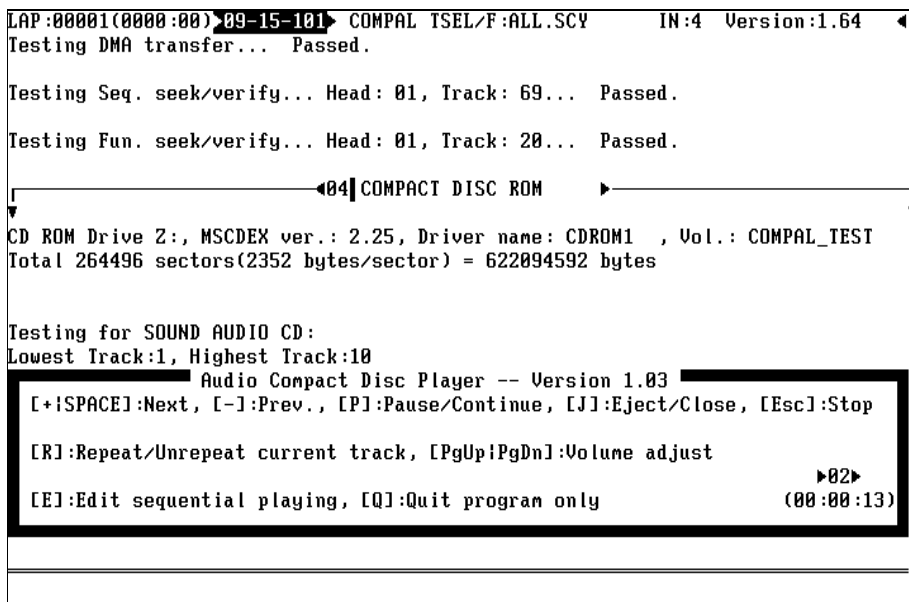

If you hear sounds from left/right speakers, then press "P" to pass this test item.

10. Keyboard Test

Run "KEY38N2.exe". Press all keys according to this order--from left to right and from up to down to test each key's function. If the test is pass then press b + Break to continue next test.

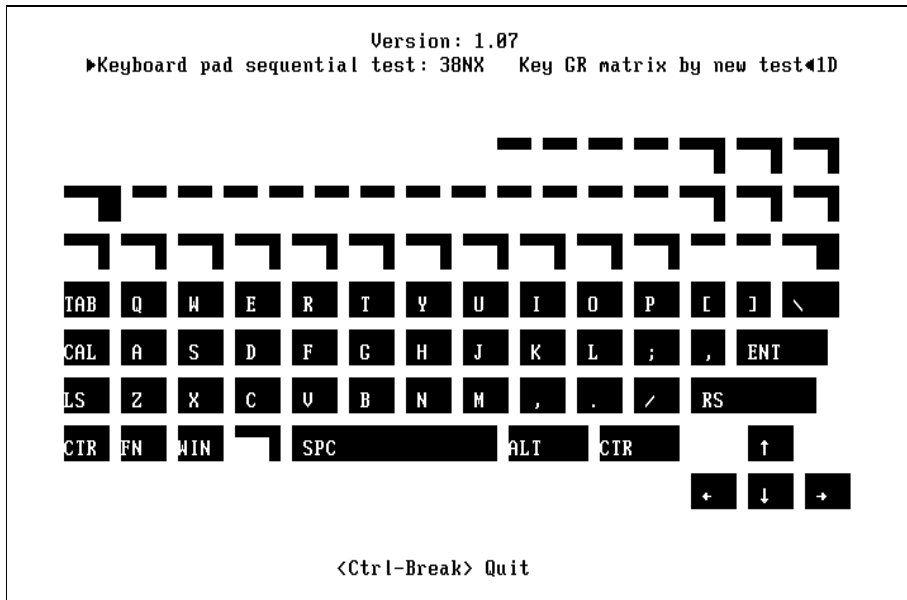

11. Caps/Scroll/Number Lock LED Indicator Test

Press keyboard Caps Lock/Num Lk/Fn+Scroll Lk to check LED indicator.

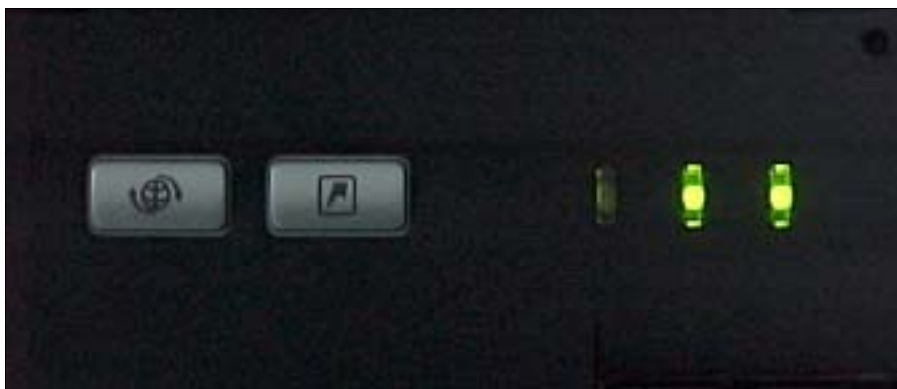

12. Syscard Test (Carbus 32bit)

Insert two pieces of Syscard (Card bus) into PCMCIA slots then run "TESTCB.exe" for testing.

```

PCCTest 450/460 CardBus test software v2.07
Texas Instruments PCI-1420 on Bus 2, Function 0, Device 0, Controller 1
Current Slot = 0 PCI Bus = 3 Scratch Buffer = 3600:0000
CardBus Socket Registers = 000D2000 Test Memory Window = 000D0000 CBus = 3
Checking Socket Controller.....Passed
Power on delay (Vcc = 3.3 volt).....Complete
Basic Operational Test.....Passed
Data Pattern Test.....Passed
Parity Error Test (CPERR#).....Passed
Parity Test (CPAR).....Passed
CSERR# Test.....Passed
Vcc Test.....Passed
Speaker Test.....Passed
CSTSCHG Test.....Passed
CINT# Test.....Passed
CRST# Test.....Passed
CCLKRUN# Test.....Passed
Slave Abort (CSTOP#) Test.....Passed
PCCTest model number 460 - Version 1.05
Configuring PCCTest Master Mode (M3)....Complete
Master Mode Read Test.....Passed
Master Mode Write Test.....Passed
Test completed with 0 errors - PASSED
Press any key to continue . . .

```

13. Battery Charge Test

Insert AC adapter to the system, then run "591NEW2.exe" for testing.

```

ONLY FOR 87591 Series Battery Test Program.[591] V1.3 2001/11/15
MAIN Battery

Manufacturer: Sony                      Serial Number : 10203

Design Capacity Value      = 5800mAh
Battery fullcharge Capacity = 5800mAh
Design Voltage Value       = 14800mV [Lion]

```

Machine Disassembly and Replacement

This chapter contains step-by-step procedures on how to disassemble the notebook computer for maintenance and troubleshooting.

To disassemble the computer, you need the following tools:

- Wrist grounding strap and conductive mat for preventing electrostatic discharge
- Philips screw driver
- Flat blade screwdriver
- Tweezers
- Nut screwdriver

NOTE: The screws for the different components vary in size. During the disassembly process, group the screws with the corresponding components to avoid mismatch when putting back the components. When you remove the stripe cover, please be careful not to scrape the cover.

General Information

Before You Begin

Before proceeding with the disassembly procedure, make sure that you do the following:

1. Turn off the power to the system and all peripherals.
2. Unplug the AC adapter and all power and signal cables from the system.
3. Remove the battery pack.
4. The two screws that secure the power board LS-1257 on the upper case are **M2.5x4**. Please make sure you use the right screws. Otherwise, other screws that are too long may damage the main board as you secure the power board to the upper case.

NOTE: Aspire 1400 uses mylar or tape to fasten the FFC/FPC/connectors/cable, you may need to tear the tape or mylar before you disconnect different FFC/FPC/connectors.

Disassembly Procedure Flowchart

The flowchart on the succeeding page gives you a graphic representation on the entire disassembly sequence and instructs you on the components that need to be removed during servicing. For example, if you want to remove the system board, you must first remove the keyboard, then disassemble the inside assembly frame in that order.

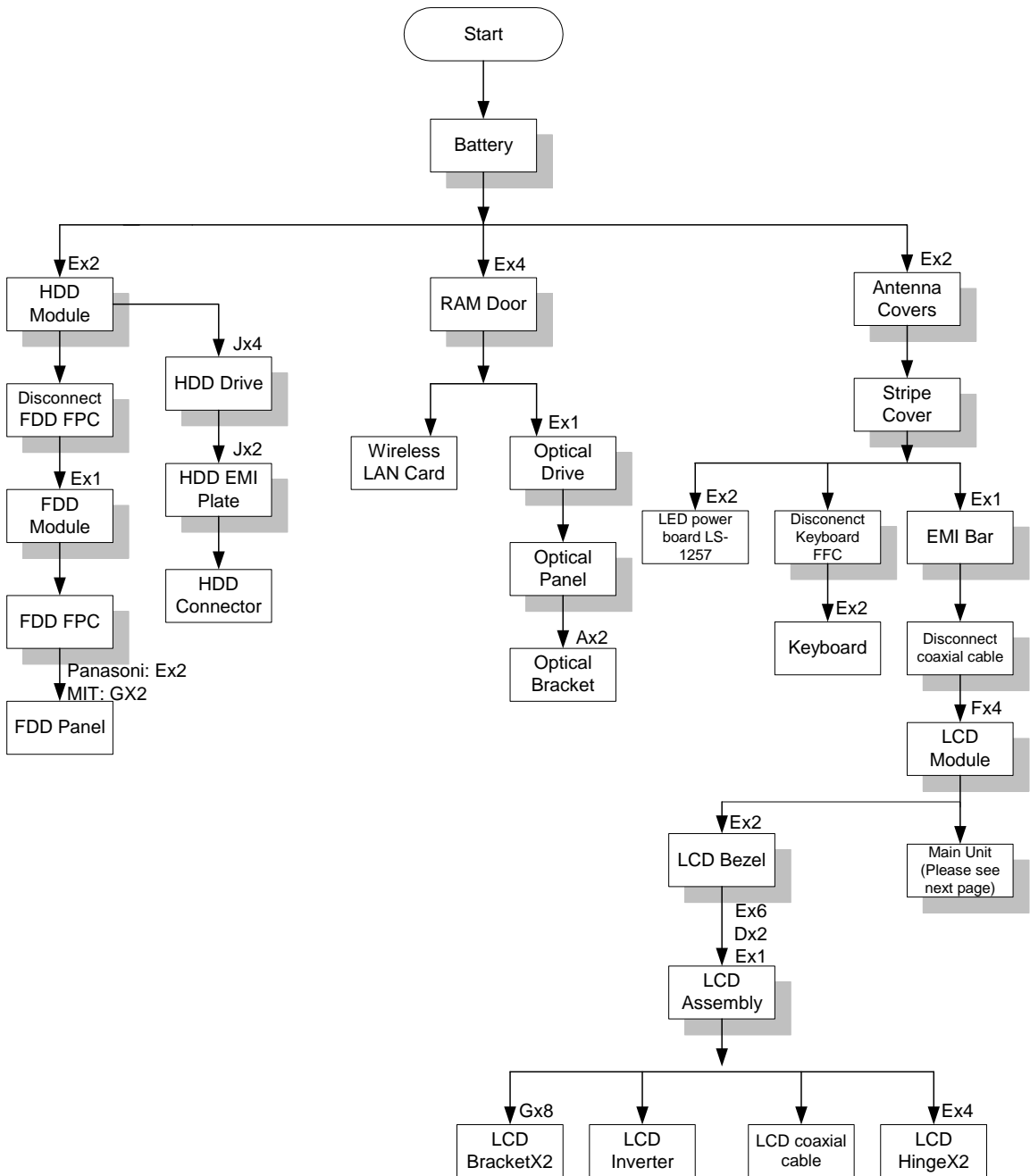

Removing the Battery Pack

1. Slide the battery latch to the left.
2. Then remove the battery.



Removing the HDD Module/FDD Module/RAM Door and Optical Drive

1. Remove the two screws that secure the HDD module.
2. Then take the HDD module away.



3. Disconnect the FDD FPC. Then turn out the screw that secure the FDD module. Push the FDD module out.



4. Turn out the four screws on the RAM door. Then remove the RAM door.



5. Next, remove the screw that secure the optical drive. Push and take the optical drive away.



Removing the LCD Module/the Power Board and the Keyboard

Removing the LCD Module

1. Remove the two (one on each side) screws holding the LCD antenna covers.
2. Then take away the antenna cover.



3. Open the LCD to an angle of 95 degree from the main unit. Then remove the strip cover (middle cover).
4. Turn out the two screws on the rear panel. One on each side.
5. Then remove the two screws on the button panel. One on the left and the other on the right.



6. Remove the screw that secure the EMI bar. Then remove the EMI bar.
7. Disconnect the coaxial cable connector.
8. Then, you can remove the entire LCD module.



Removing the Power Board and the Keyboard

1. Remove the two screws holding the power board. Then remove the power board.
2. Turn out the two (one on each side) screws that secure the keyboard.
3. Disconnect the keyboard FFC. After disconnect the keyboard connector then remove the keyboard.



Disassembling the Main Unit

Separate the main unit into the logic upper and the logic lower assembly

1. Disconnect the FFC.
2. Disconnect the FDD FPC..



3. Remove the 7 screws on the upper case.
4. Turn out one screw on the rear panel.
5. Then remove the two (one on each side) screws on the button pane...



6. Remove the 5 screw on the right panel.
7. Then separate the logic upper from the logic lower.



Disassembling the logic upper

1. Turn out the seven holding the right and the hinge saddles. Then remove the hinge saddles.
2. Remove the five screws that secure the EMI shielding. Then remove the EMI shielding.



3. Disconnect the LED board FFC.
4. Tear off the aluminum foil on the LED board.
5. Remove the two screws holding the LED board assembly.
6. Then remove the two screws that secure the LED board to the LED board bracket. Then you can remove the LED board from the bracket..



7. Disconnect the LED board FFC.
8. Disconnect touchpad FFC from the touchpad.
9. Slide the touchpad bracket to left then remove the touchpad bracket. Then you can remove the touchpad (with touchpad FFC) from the upper case.



10. Disconnect the touchpad FFC.
11. Remove the screw that holds the touchpad board.



12. Take away the touchpad board from the upper case.
13. Disconnect LED 22 pins FFC from touchpad board.
14. Disconnect the FDD FFC.



Disassembling the logic lower

1. Pull the Dimm socket with fingers gently and take out the memory from the DIMM socket.
2. Release the tape that fasten the speakers' wire.
3. Disconnect speakers' wire.



4. Remove the two screws holding the two speakers. One on each side. Then remove the speakers.
5. Remove the two screws that secure the main board.
6. Next, take out the main board from the lower case.

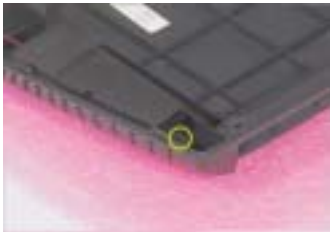

7. Turn out the four screws on the main board. Then remove the optical bracket.
8. Turn out the two screws that secure the modem card.
9. Then turn over the modem card and disconnect the modem card cable.



10. Remove the four screws and take the heatsink away.
11. Release the CPU lock with a tool and remove the CPU from CPU support bracket.
12. Turn out the three screws that secure the fan and then remove the fan from the main board.



13. Remove the four screws holding the CPU support plate and CPU support bracket. Then remove these two parts from the main board.
14. Turn out the four screws holding the PCMCIA slot and remove it.
15. Remove the four screwlock holding the D-sub bracket to the main board. Then remove the D-sub bracket.



Disassembling the LCD Module

1. Remove the two screwpad then turn out the two screws on the LCD bezel.
2. Disattach the LCD bezel carefully.
3. Unscrew the three screws holding the inverter board.



4. Turn out the six screws that secure the LCD to the LCD panel.
5. Then remove the LCD from the LCD panel.
6. Unfasten the kapton on LCD FPC, then disconnect the LCD FPC and remove it.



7. Disconnect the LCD inverter cable. Then remove the LCD inverter.
8. Release the kapton that fastens the LCD coaxial cable. Disconnect the coaxial cable from the LCD.
9. Turn out the eight screws holding the LCD brackets. And then remove the LCD brackets.



10. Remove the four screws that secure the two LCD hinges.
11. Take away the two LCD hinges from the LCD panel.



Disassembling the External Modules

Disassembling the HDD Module

1. Remove the four (two on each side) screws on HDD carrier. Then you can take out the HDD drive from the carrier.
2. Turn out the two screws holding the HDD EMI plate then remove it.
3. Disconnect the hard disk drive connector.



Disassembling the Floppy Disk Drive Module

1. Release the kapton that fastens the FDD FPC, then disconnect the floppy disk drive FFC.
2. Unscrew the two screw holding the FDD door. One on each side.
3. Use a tool (a tip of a pen or an uncurved paper clipper) to release the FDD door lock on one side, then the other. And you can remove the FDD door.



Disassembling the Optical Drive Module

1. Unscrew the two screws holding the optical bracket.
2. Then remove the optical bracket.



Troubleshooting

Use the following procedure as a guide for computer problems.

NOTE: The diagnostic tests are intended to test this model (Aspire 1400 series). Non-Acer products, prototype cards, or modified options can give false errors and invalid system responses.

1. Obtain the failed symptoms in as much detail as possible.
2. Verify the symptoms by attempting to re-create the failure by running the diagnostic test or by repeating the same operation.
3. If any problem occurs, you can perform visual inspection before you follow this chapter's instructions. You can check the following:
 - power cords are properly connected and secured;
 - there are no obvious shorts or opens;
 - there are no obviously burned or heated components;
 - all components appear normal.
4. Use the following table with the verified symptom to determine which page to go to.

Symptoms (Verified)	Go To
Power failure. (The power indicator does not go on or stay on.)	"Power System Check" on page 71.
POST does not complete. No beep or error codes are indicated.	"Power-On Self-Test (POST) Error Message" on page 73 "Undetermined Problems" on page 81
POST detects an error and displayed messages on screen.	"Error Message List" on page 74
The diagnostic test detected an error and displayed a FRU code.	"System Diagnostic Diskette" on page 48
Other symptoms (i.e. LCD display problems or others).	"Power-On Self-Test (POST) Error Message" on page 73
Symptoms cannot be re-created (intermittent problems).	Use the customer-reported symptoms and go to "Power-On Self-Test (POST) Error Message" on page 73 "Intermittent Problems" on page 80 "Undetermined Problems" on page 81

System Check Procedures

External Diskette Drive Check

Do the following steps to isolate the problem to a controller, driver, or diskette. A write-enabled, diagnostic diskette is required.

NOTE: Make sure that the diskette does not have more than one label attached to it. Multiple labels can cause damage to the drive or cause the drive to fail.

Do the following to select the test device. See “System Diagnostic Diskette” on page 48 for details.

1. Boot from diagnostic program (see “System Diagnostic Diskette” on page 48)
2. If an error occurs with the internal diskette drive, reconnect the diskette connector on the main board.

If the error still remains:

1. Reconnect the external diskette drive/CD-ROM module.
2. Replace the external diskette drive/CD-ROM module.
3. Replace the main board.

External CD-ROM Drive Check

Do the following to isolate the problem to a controller, drive, or CD-ROM. Make sure that the CD-ROM does not have any label attached to it. The label can cause damage to the drive or can cause the drive to fail.

Do the following to select the test device:

1. Boot from the diagnostics diskette and start the diagnostics program (refer to “System Diagnostic Diskette” on page 48).
2. See if CD-ROM Test is passed when the program runs to CD-ROM Test.
3. Follow the instructions in the message window.

If an error occurs, reconnect the connector on the main board. If the error still remains:

1. Reconnect the external diskette drive/CD-ROM module.
2. Replace the external diskette drive/CD-ROM module.
3. Replace the main board.

Keyboard or Auxiliary Input Device Check

Remove the external keyboard if the internal keyboard is to be tested.

If the internal keyboard does not work or an unexpected character appears, make sure that the flexible cable extending from the keyboard is correctly seated in the connector on the main board.

If the keyboard cable connection is correct, run the Keyboard Test. See “System Diagnostic Diskette” on page 48 for more details.

If the tests detect a keyboard problem, do the following one at a time to correct the problem. Do not replace a non-defective FRU:

1. Reconnect the keyboard cables.
2. Replace the keyboard.
3. Replace the main board.

The following auxiliary input devices are supported by this computer:

- Embedded numeric keypad
- External keyboard

If any of these devices do not work, reconnect the cable connector and repeat the failing operation.

Memory Check

Memory errors might stop system operations, show error messages on the screen, or hang the system.

1. Boot from the diagnostics diskette and start the doagmpstotics program (please refer to “System Diagnostic Diskette” on page 48).
2. Go to the diagnostic memory in the test items.
3. Press F2 in the test items.
4. Follow the instructions in the message window.

NOTE: Make sure that the DIMM is fully installed into the connector. A loose connection can cause an error.

Power System Check

To verify the symptom of the problem, power on the computer using each of the following power sources:

1. Remove the battery pack.
2. Connect the power adapter and check that power is supplied.
3. Disconnect the power adapter and install the charged battery pack; then check that power is supplied by the battery pack.

If you suspect a power problem, see the appropriate power supply check in the following list:

- “Check the Battery Pack” on page 72

Check the Battery Pack

To check the battery pack, do the following:

From Software:

1. Check out the Power Management in control Panel
2. In Power Meter, confirm that if the parameters shown in the screen for Current Power Source and Total Battery Power Remaining are correct.
3. Repeat the steps 1 and 2, for both battery and adapter.
4. This helps you identify first the problem is on recharging or discharging.

From Hardware:

1. Power off the computer.
2. Remove the battery pack and measure the voltage between battery terminals 1(+) and 6(ground). See the following figure
3. If the voltage is still less than 7.5 Vdc after recharging, replace the battery.

To check the battery charge operation, use a discharged battery pack or a battery pack that has less than 50% of the total power remaining when installed in the computer.

If the battery status indicator does not light up, remove the battery pack and let it return to room temperature. Re-install the battery pack.

If the charge indicator still does not light up, replace the battery pack. If the charge indicator still does not light up, replace the DC/DC charger board.

Touchpad Check

If the touchpad doesn't work, do the following actions one at a time to correct the problem. Do not replace a non-defective FRU:

1. After rebooting, run Tracking Pad PS2 Mode Driver. For example, run Syn touch driver.
2. Run utility with the PS/2 mouse function and check if the mouse is working.
3. If the the PS/2 mouse does not work, then check if the main board to switch board FPC is connected well.
4. If the main board to switch board FPC is connected well, then check if the FFC on touch pad PCB connects properly.
5. If the FFC on touch pad PCB connects properly, then check if LS851 JP1 Pin6=5V are pulese. If yes, then replace touch pad PCB. If no, then go to next step.
6. Replace switch board.
7. If the touch pad still does not work, then replace the FPC on Track Pad PCB.

After you use the touchpad, the pointer drifts on the screen for a short time. This self-acting pointer movement can occur when a slight, steady pressure is applied to the touchpad pointer. This symptom is not a hardware problem. No service actions are necessary if the pointer movement stops in a short period of time.

Power-On Self-Test (POST) Error Message

The POST error message index lists the error message and their possible causes. The most likely cause is listed first.

NOTE: Perform the FRU replacement or actions in the sequence shown in FRU/Action column, if the FRU replacement does not solve the problem, put the original part back in the computer. Do not replace a non-defective FRU.

This index can also help you determine the next possible FRU to be replaced when servicing a computer.

If the symptom is not listed, see “Undetermined Problems” on page 81.

The following lists the error messages that the BIOS displays on the screen and the error symptoms classified by function.

NOTE: Most of the error messages occur during POST. Some of them display information about a hardware device, e.g., the amount of memory installed. Others may indicate a problem with a device, such as the way it has been configured.

NOTE: If the system fails after you make changes in the BIOS Setup Utility menus, reset the computer, enter Setup and install Setup defaults or correct the error.

Index of Error Messages

Error Code List

Error Codes	Error Messages
006	Equipment Configuration Error
010	Equipment Configuration Error
070	Real Time Clock Error 1
071	CMOS Battery Bad 4
072	CMOS Checksum Error 1
080	Battery Is Critical Low 1
110	Incorrect password specified, system halted 1

Error Message List

Error Messages	FRU/Action in Sequence
0200 Failure Fixed Disk	Hard disk error detected. Check to see if fixed disk is attached properly. Enter the BIOS Setup Utility and verify the hard disk is detected.
0211 Keyboard error	see "Keyboard or Auxiliary Input Device Check" on page 71.
0212 Keyboard Controller Failed	see "Keyboard or Auxiliary Input Device Check" on page 71. May require replacing the keyboard controller.
0213 Keyboard locked - Unlock key switch	Unlock the system to proceed.
0220 Monitor type does not match CMOS - Run SETUP	Display device mismatch. Enter the BIOS Setup Utility and verify the parameters (try loading the default settings); then save and restart the computer.
0230 Shadow RAM Failed at offset: nnnn	Shadow RAM test failed Main board
0231 System RAM Failed at offset: nnnn	System RAM test failed Main board
0232 Extended RAM Failed at offset: nnnn	Extended RAM test failed Main board
0250 System battery is dead - Replace and run SETUP	CMOS clock battery needs to be replaced. Replace the battery and run BIOS Setup Utility to reconfigure system time, then reboot system.
0251 System CMOS checksum bad - Default configuration used	CMOS has been corrupted or modified incorrectly. Run BIOS Setup Utility and verify the parameters; then save and restart the computer. Check the system battery.
0260 System timer error	System timer test failed, and the main board needs to be repaired. Run BIOS Setup Utility to reconfigure system time, then reboot system. Main board
0270 Real time clock error	RTC battery Run BIOS Setup Utility to reconfigure system time, then reboot system. Main board
0280 Previous boot incomplete - Default configuration used	Previous boot-up was not completed successfully. Enter the BIOS Setup Utility and verify the parameters (try loading the default settings); then save and restart the computer. RTC battery Main board
0281 Memory size found by POST differed from CMOS	Run "Load Setup Defaults" in BIOS Setup Utility. Main board

Error Message List

Error Messages	FRU/Action in Sequence
02B0 Diskette drive A/B error	Drive A: or B: is present but fails the BIOS POST diskette tests. Check the drive is defined with the proper diskette type in BIOS Setup Utility Check if the diskette drive is attached correctly. See "External Diskette Drive Check" on page 70.
02B2 Incorrect Drive A type - run SETUP	Type of floppy drive A: not correctly identified in Setup. Main board
02D0 System cache error - Cache disabled	RAM cache failed and BIOS disabled the cache. On older boards, check the cache jumpers. You may have to replace the cache. Main board
02F0 CPU ID	CPU socket number for Multi-Processor error. Main board
02F4 EISA CMOS not writeable	System unable to write to EISA CMOS. Main board
02F5 DMA Test Failed	System unable to write to DMA (Direct Memory Access) registers. Main board
02F6 Software NMI Failed	System unable to generate software NMI (Non-Maskable Interrupt). Main board
02F7 Fail-Safe Timer NMI Failed	Fail-Safe Timer takes too long. Main board
<i>device</i> Address Conflict	Specific device has an address conflict. Enter the BIOS Setup Utility and verify the parameters (try loading the default settings); then save and restart the computer. RTC battery Main board
Failing Bits: <i>nnnn</i>	Memory test failed. DIMM BIOS ROM Main board
Invalid System Configuration Data	Error with NVRAM (CMOS) data. Enter the BIOS Setup Utility and verify the parameters (try loading the default settings); then save and restart your computer. Main board
I/O device IRQ conflict	I/O device has IRQ (Interrupt Request) conflict. Enter the BIOS Setup Utility and verify the parameters (try loading the default settings); then save and restart the computer. RTC battery Main board
Operating system not found	Operating system cannot be found on the boot device. Enter the BIOS Setup Utility and verify the parameters (try loading the default settings); then save and restart the computer. Recover hard disk. Reinstall the operating system.
Parity Check 1 <i>nnnn</i>	Parity error found on system bus. BIOS attempts to locate the address and display it on the screen. If it cannot locate the address, it displays.
Parity Check 2 <i>nnnn</i>	Parity error found on I/O bus. BIOS attempts to locate the address and display it on the screen. If it cannot locate the address, it displays .

Error Message List

No beep Error Messages	FRU/Action in Sequence
No beep, power-on indicator turns off and LCD is blank.	Power source (battery pack and power adapter). See "Power System Check" on page 71. Ensure every connector is connected tightly and correctly. Reconnect the DIMM. LED board. Main board.
No beep, power-on indicator turns on and LCD is blank.	Power source (battery pack and power adapter). See "Power System Check" on page 71. Reconnect the LCD connector Hard disk drive LCD inverter ID LCD cable LCD Inverter LCD Main board
No beep, power-on indicator turns on and LCD is blank. But you can see POST on an external CRT.	Reconnect the LCD connectors. LCD inverter ID LCD cable LCD inverter LCD Main board
No beep, power-on indicator turns on and a blinking cursor shown on LCD during POST.	Ensure every connector is connected tightly and correctly. Main board
No beep during POST but system runs correctly.	Speaker Main board

Index of Symptom-to-FRU Error Message

LCD-Related Symptoms

Symptom / Error	Action in Sequence
LCD backlight doesn't work LCD is too dark LCD brightness cannot be adjusted LCD contrast cannot be adjusted	Enter BIOS Utility to execute "Load Setup Defaults" on Exit screen, then reboot system. Reconnect the LCD connectors. Keyboard (if contrast and brightness function key doesn't work). LCD inverter ID LCD cable LCD inverter LCD Main board
Unreadable LCD screen Missing pels in characters Abnormal screen Wrong color displayed	Reconnect the LCD connector LCD inverter ID LCD cable LCD inverter LCD Main board
LCD has extra horizontal or vertical lines displayed.	LCD inverter ID LCD inverter LCD cable LCD Main board

Indicator-Related Symptoms

Symptom / Error	Action in Sequence
Indicator incorrectly remains off or on, but system runs correctly	Reconnect the inverter board Inverter board Main board

Power-Related Symptoms

Symptom / Error	Action in Sequence
Power shuts down during operation	Power source (battery pack and power adapter). See "Power System Check" on page 71. Battery pack Power adapter Hard drive & battery connection board Main board
The system doesn't power-on.	Power source (battery pack and power adapter). See "Power System Check" on page 71. Battery pack Power adapter Hard drive & battery connection board Main board
The system doesn't power-off.	Power source (battery pack and power adapter). See "Power System Check" on page 71. Hold and press the power switch for more than 4 seconds. Main board
Battery can't be charged	See "Check the Battery Pack" on page 72. Battery pack Main board

PCMCIA-Related Symptoms

Symptom / Error	Action in Sequence
System cannot detect the PC Card (PCMCIA)	PCMCIA slot assembly Main board
PCMCIA slot pin is damaged.	PCMCIA slot assembly

Memory-Related Symptoms

Symptom / Error	Action in Sequence
Memory count (size) appears different from actual size.	DIMM Main board

Speaker-Related Symptoms

Symptom / Error	Action in Sequence
In Windows, multimedia programs, no sound comes from the computer.	Audio driver Speaker Main board
Internal speakers make noise or emit no sound.	Speaker Main board

Power Management-Related Symptoms

Symptom / Error	Action in Sequence
The system will not enter hibernation	Keyboard (if control is from the keyboard) Hard disk drive Main board
The system doesn't enter hibernation mode and four short beeps every minute.	Press Fn+F4 and see if the computer enters hibernation mode. Touchpad Keyboard Hard disk connection board Hard disk drive Main board
The system doesn't enter standby mode after closing the LCD	LCD cover switch Main board
The system doesn't resume from hibernation mode.	Hard disk connection board Hard disk drive Main board
The system doesn't resume from standby mode after opening the LCD.	LCD cover switch Main board
Battery fuel gauge in Windows doesn't go higher than 90%.	Remove battery pack and let it cool for 2 hours. Refresh battery (continue use battery until power off, then charge battery). Battery pack Main board
System hangs intermittently.	Reconnect hard disk/CD-ROM drives. Hard disk connection board Main board

Peripheral-Related Symptoms

Symptom / Error	Action in Sequence
System configuration does not match the installed devices.	Enter BIOS Setup Utility to execute "Load Setup defaults", then reboot system. Reconnect hard disk/CD-ROM/diskette drives.
External display does not work correctly.	See "System Diagnostic Diskette" on page 48 See if there is an error beep. If there is an error beep, then change main board. Power off. Then check if RAM CPU BIOS are well-connected. Press Fn+F5 three times slowly LCD FPC LCD inverter LCD
USB does not work correctly	See "System Diagnostic Diskette" on page 48 Main board
Print problems.	Ensure the "Parallel Port" in the "System Devices" of BIOS Setup Utility is set to Enabled. Onboard Devices Configuration Run printer self-test. Printer driver Printer cable Printer Main board

Keyboard/Touchpad-Related Symptoms

Symptom / Error	Action in Sequence
Keyboard (one or more keys) does not work.	Reconnect the keyboard cable. Keyboard Main board
Touchpad does not work.	Reconnect touchpad cable. Touchpad board Main board

Modem-Related Symptoms

Symptom / Error	Action in Sequence
Internal modem does not work correctly.	See "System Diagnostic Diskette" on page 48. Modem phone port modem combo board Main board

NOTE: If you cannot find a symptom or an error in this list and the problem remains, see "Undetermined Problems" on page 81.

Intermittent Problems

Intermittent system hang problems can be caused by a variety of reasons that have nothing to do with a hardware defect, such as: cosmic radiation, electrostatic discharge, or software errors. FRU replacement should be considered only when a recurring problem exists.

When analyzing an intermittent problem, do the following:

1. Run the advanced diagnostic test for the main board in loop mode at least 10 times.
2. If no error is detected, do not replace any FRU.
3. If any error is detected, replace the FRU. Rerun the test to verify that there are no more errors.

Undetermined Problems

The diagnostic problems does not identify which adapter or device failed, which installed devices are incorrect, whether a short circuit is suspected, or whether the system is inoperative.

Follow these procedures to isolate the failing FRU (do not isolate non-defective FRU).

NOTE: Verify that all attached devices are supported by the computer.

NOTE: Verify that the power supply being used at the time of the failure is operating correctly. (See "Power System Check" on page 71):

1. Power-off the computer.
2. Visually check them for damage. If any problems are found, replace the FRU.
3. Remove or disconnect all of the following devices:
 - Non-Acer devices
 - Printer, mouse, and other external devices
 - Battery pack
 - Hard disk drive
 - DIMM
 - CD-ROM/Diskette drive Module
 - PC Cards
4. Power-on the computer.
5. Determine if the problem has changed.
6. If the problem does not recur, reconnect the removed devices one at a time until you find the failing FRU.
7. If the problem remains, replace the following FRU one at a time. Do not replace a non-defective FRU:
 - Main board
 - LCD assembly

Index of AFlash BIOS Error Message

Error Message	Action in Sequence
Hardware Error	See "System Diagnostic Diskette" on page 48
VPD Checksum Error	Reboot the system and then retest with this diskette.
BIOS Update Program Error	Turn off the power and restart the system.
System Error	Make sure this AFlash BIOS diskette for this model.
Without AC adapter	make sure to connect AC adapter
Battery Low	make sure to install a highly charged battery, and reboot system.

Jumper and Connector Locations

Top View

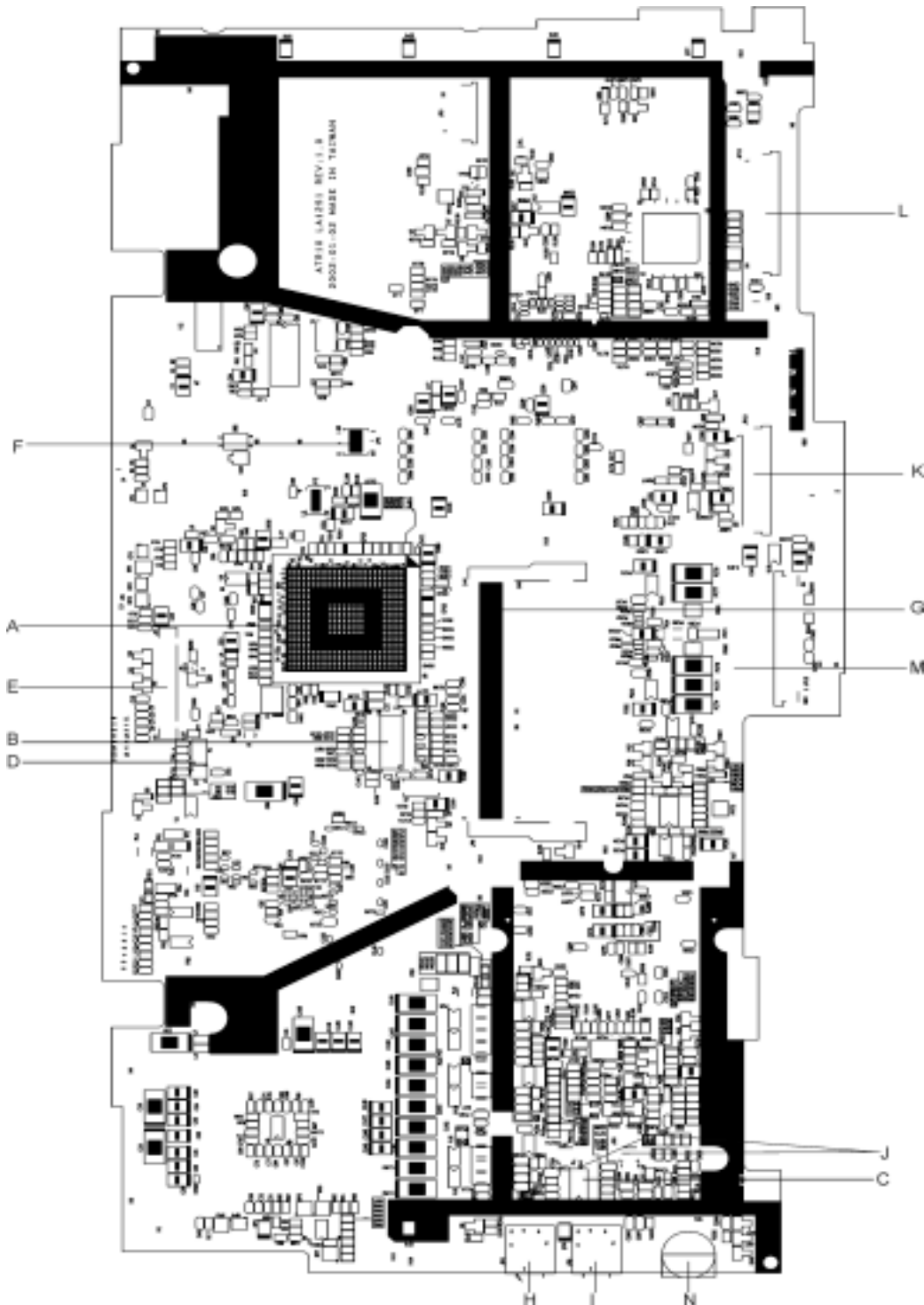

E-JP1	LCD Connector	F-JP2	Power Button Board Connector
G-JP5	SODIMM Connector	H-JP6	Microphone Jack
I-JP8	Earphones Jack	J-JP7, JP9	Speaker Connector
K-JP10	Main Board to Touch Pad Board FFC connector	L-JP11	Main Board to Touch Pad Board FPC Connector
M-JP12	JP12 Keyboard Connector		

SW1 Settings (Lid switch)

	Setting
Switch 1	NONE
Switch 2	STAND BY
Switch 3	HIBERNATE
Switch 4	ON/OFF BUTTON

SW2 Settings

SW2	Setting
POWER BUTTON	ON: SYSTEM ON OFF: SYSTEM OFF

Bottom View

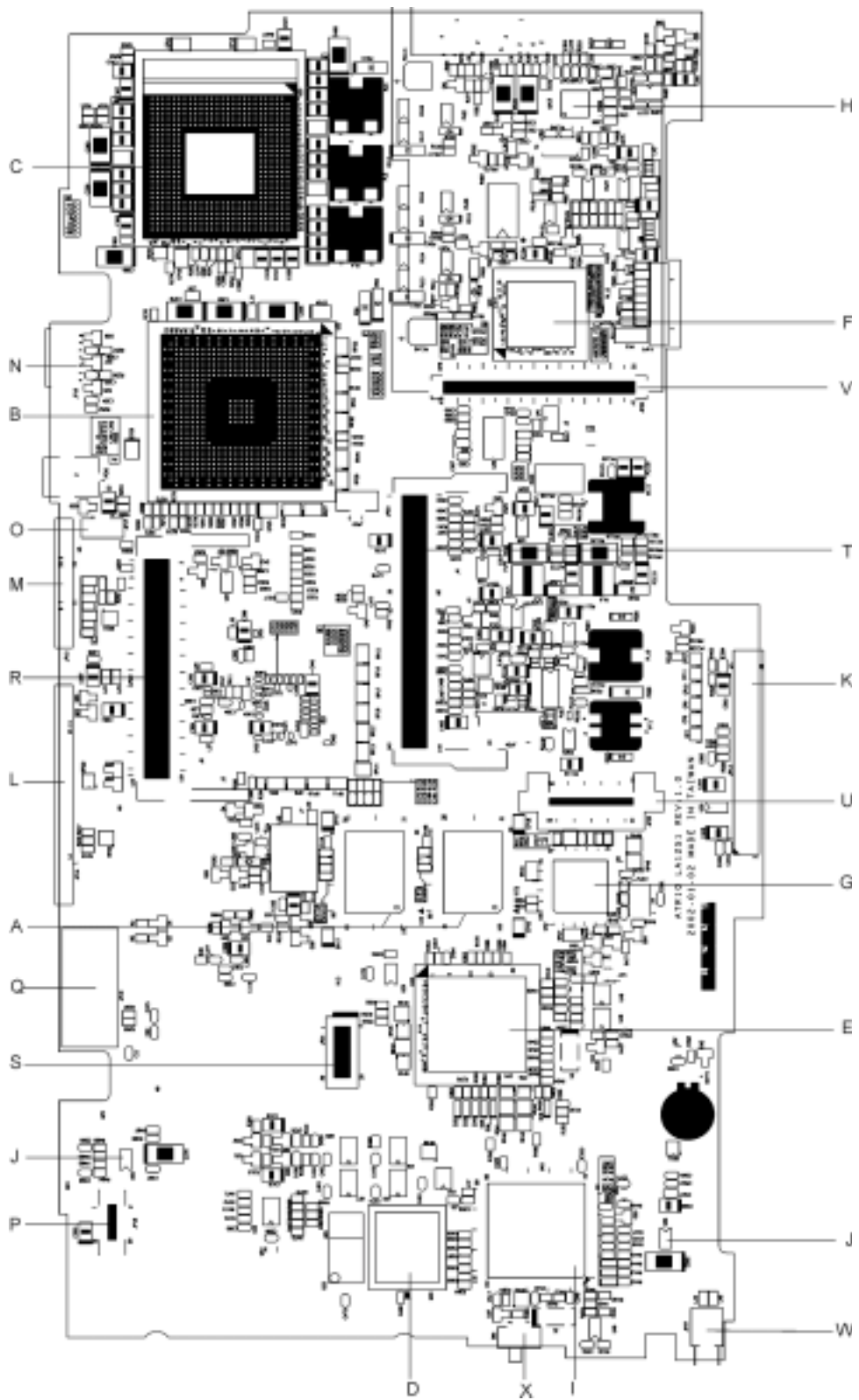

K-JP13	HDD Connector	L-JP14	Parallel Connector
M-JP15	CRT Connector	N-JP16	S-Video Connector
O-JP17	Fan Connector	P-JP18	M/B to USB Board Connector
Q-JP19	LAN/Modem Connector	R-JP20	MINI PCI Connector
S-JP21	MDC Module Connector	T-JP23	SODIMM Connector
U-JP25	CDROM Connector	V-JP26	PCMCIA Connector
W-JP27	USB Connector		

FRU (Field Replaceable Unit) List

This chapter gives you the FRU (Field Replaceable Unit) listing in global configurations of Aspire 1400. Refer to this chapter whenever ordering for parts to repair or for RMA (Return Merchandise Authorization).

Please note that WHEN ORDERING FRU PARTS, you should check the most up-to-date information available on your regional web or channel. For whatever reasons a part number change is made, it will not be noted on the printed Service Guide. For ACER AUTHORIZED SERVICE PROVIDERS, your Acer office may have a DIFFERENT part number code from those given in the FRU list of this printed Service Guide. You MUST use the local FRU list provided by your regional Acer office to order FRU parts for repair and service of customer machines.

NOTE: To scrap or to return the defective parts, you should follow the local government ordinance or regulations on how to dispose it properly, or follow the rules set by your regional Acer office on how to return it.

Exploded Diagram

THE SYSTEM

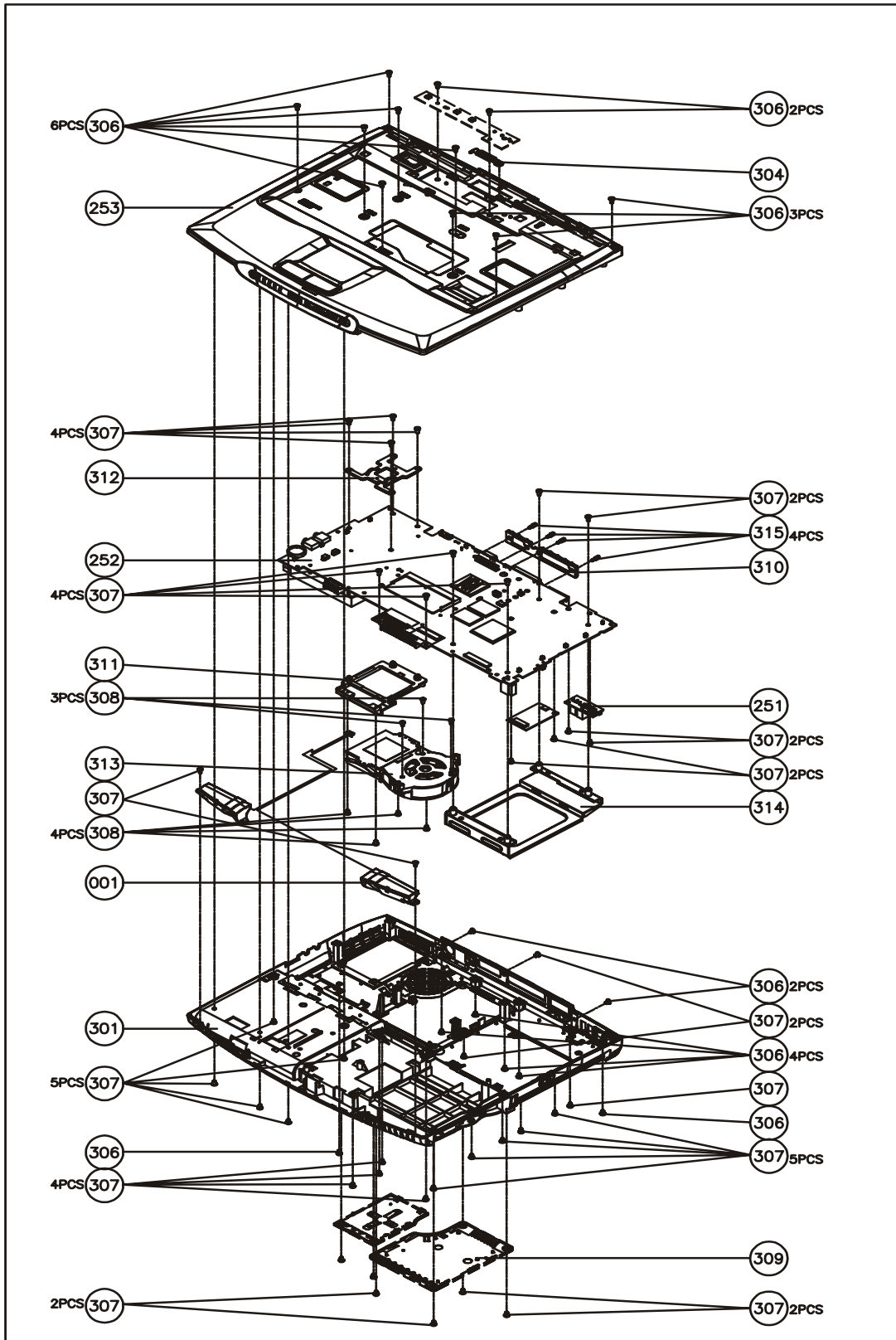

LOGIC UPPER ASSY

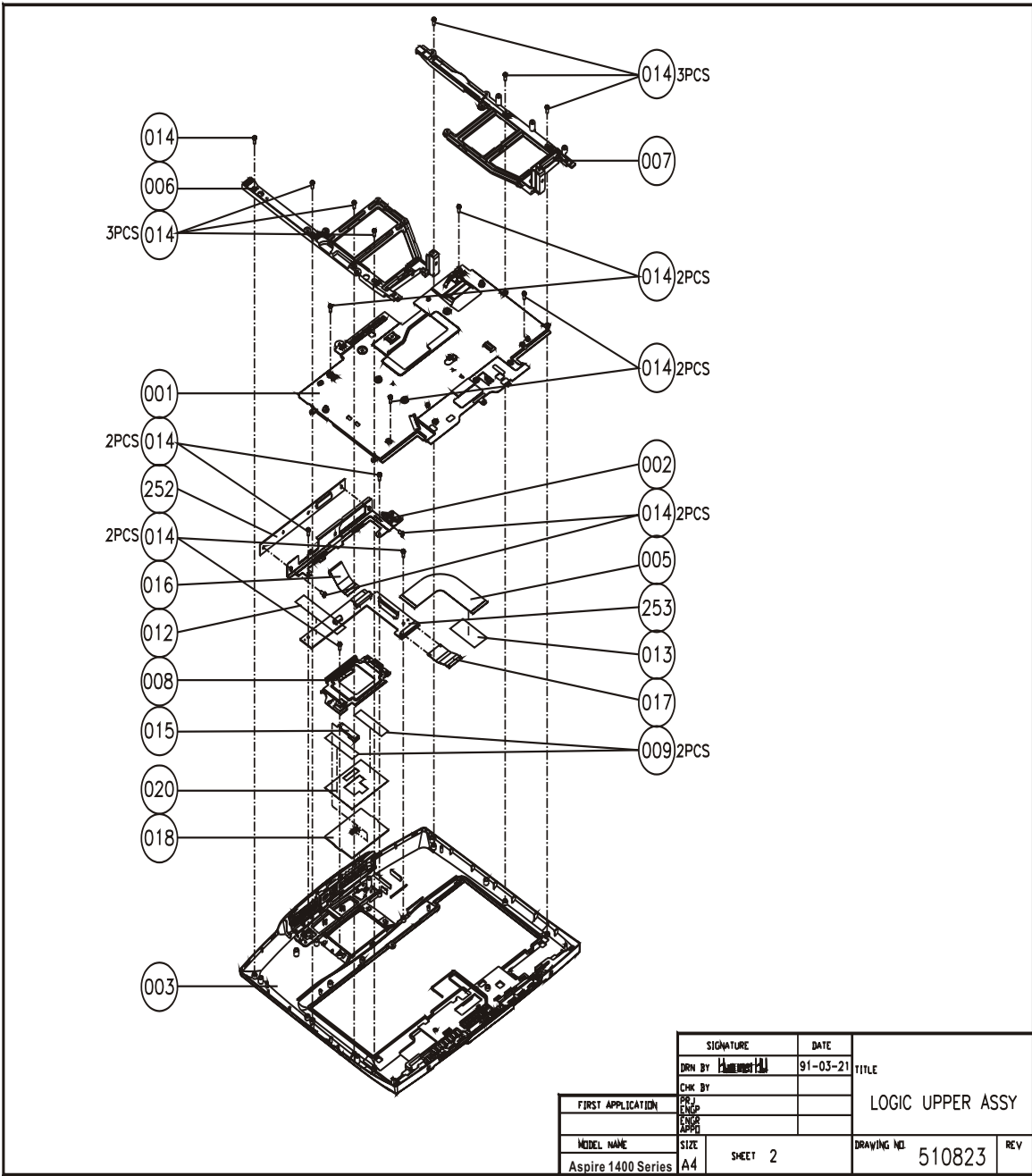

SIGNATURE		DATE	TITLE	
DRN BY: <i>[Signature]</i>		91-03-21	LOGIC UPPER ASSY	
FIRST APPLICATION	PRJ			
	ENGR			
	ASST			
MODEL NAME	SIZE	SHEET 2	DRAWING NO.	REV
Aspire 1400 Series	A4		510823	

LCD 14.1"

FOR 14.1" 001

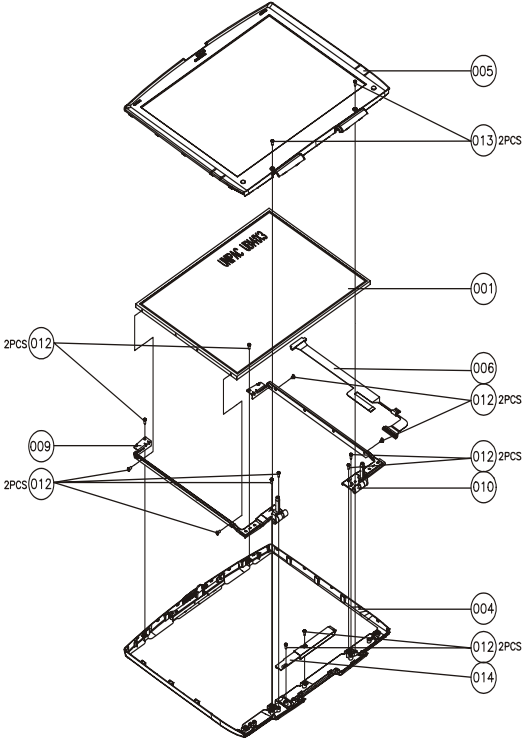

SIGNATURE		DATE	TITLE	
DRN BY: <i>[Signature]</i>		02-02-05	LCD ASSY	
FIRST APPLICATION				
CHK BY: <i>[Signature]</i>				
ENG: <i>[Signature]</i>				
APP: <i>[Signature]</i>				
Model Name	SIZE	SHEET	DRAWING NO.	REV
Aspire 1400 Series	A4	2	510833	

LCD 15"

FOR 15" 002,003,004,005,006,007

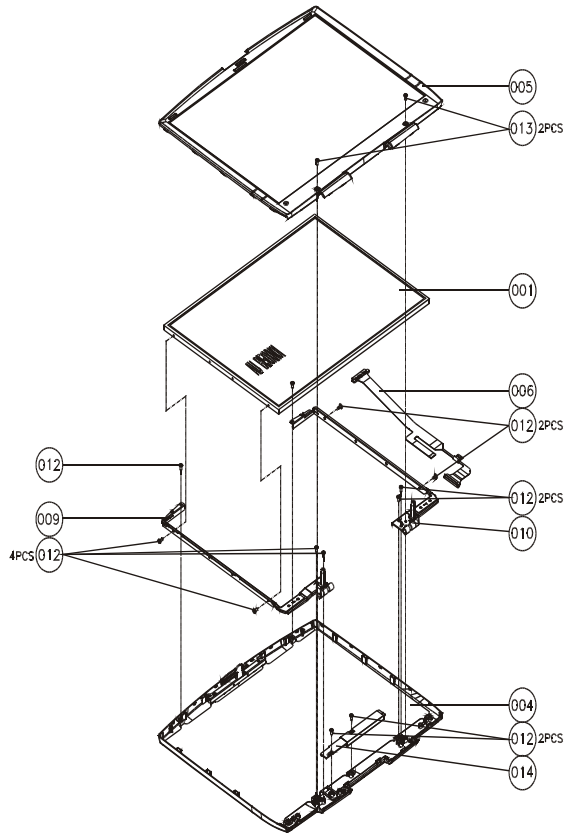

SIGNATURE		DATE	
DRAWN BY: <u>Harshad H</u>		02-02-05	
FIRST APPLICATION		TITLE	
		LCD ASSY	
MODEL NAME		DRAWING NO.	
Aspire 1400 Series		510833	
SIZE	SHEET	REV	
A4	3		

DVD ASSY

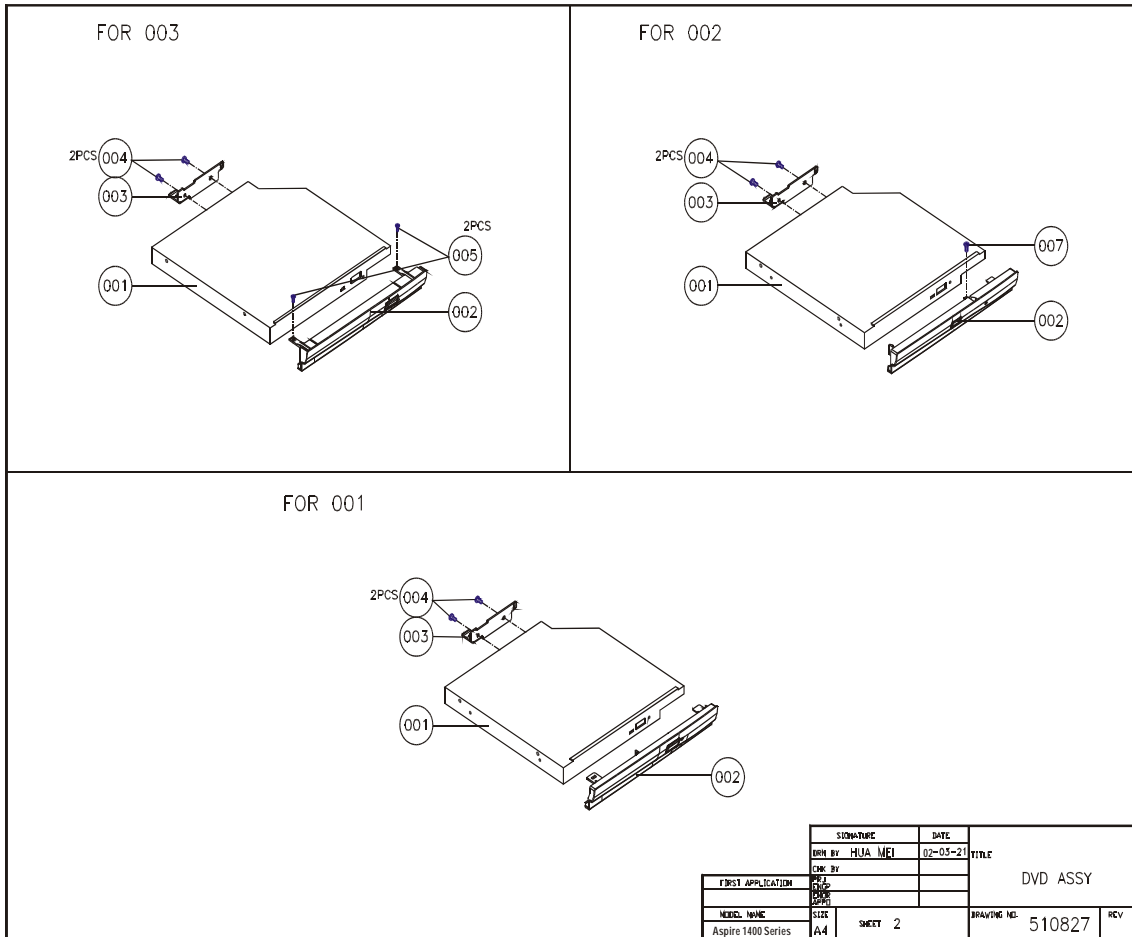

NOTE: The exploded diagrams for CD-ROM, CD-RW, DVD-ROM and DVD-RW module are the same. Therefore, we put only DVD ASSY exploded diagram as your reference. Please also refer to the FRU list below for more information on different models and part numbers. This diagram only explains the relevant location for each part. The part on the exploded diagrams may be different from its actual looks.

FDD ASSY

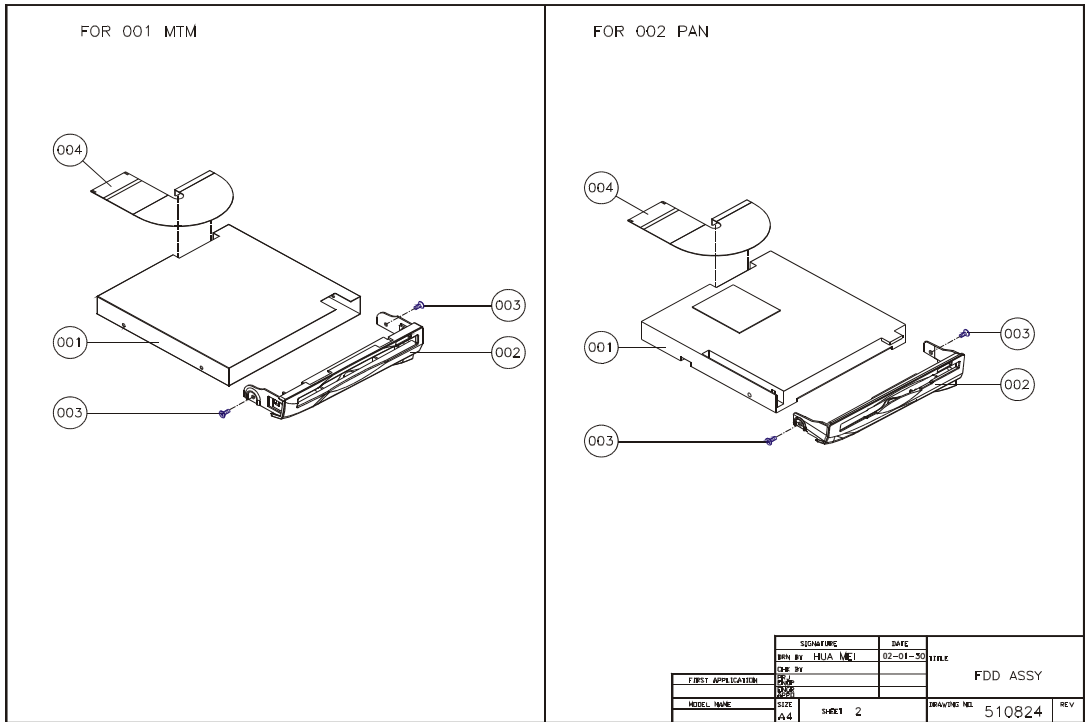

HDD (W/O HDD) ASSY

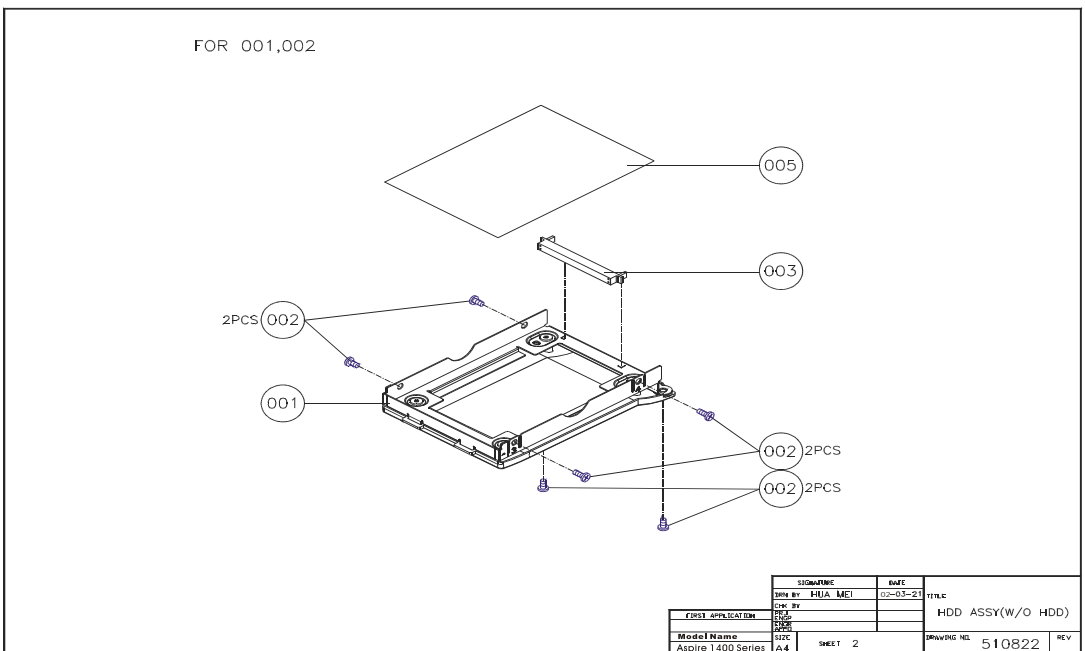

Picture	No.	Partname And Description	Part Number
CPU/Processor			
		CPU Willamette 1.7Ghz/400FSB, 256OD 478pin D-0	01.WILAM.1GV
Memory			
		256M SDRAM Mitsubishi MH32S64AVS-6TA-PE	72.03264.AON
		256M SDRAM Infineon HYS64V32220GDL-75-C2	72.64322.CON
		256MB SDRAM APACER	71.84470.111
LCD			
	LCD 14.1" and LCD 15"	ASSY LCD MODULE 14.1" XGA AU	6M.A02V5.019
		ASSY LCD MODULE 14.1" XGA SAMSUNG	6M.A02V5.020
		ASSY LCD MODULE 15.0" XGA AU	6M.A02V5.021
		ASSY LCD MODULE 15.0" XGA HANNSTAR	6M.A02V5.022
		ASSY LCD MODULE 15.0" SXGA+ CPT	6M.A02V5.023
		ASSY LCD MODULE 15.0" SXGA HANNSTAR	6M.A02V5.024
		ASSY LCD MODULE 15.0" SXGA HITACHI	6M.A02V5.025
		ASSY LCD MODULE 15.0" UXGA IBM	6M.A02V5.026
	001-LCD 14.1" and LCD 15"	LCD 14.1" TFT XGA UB141X03 (AU)	LK.A0205.001
		LCD 14.1" TFT XGA LTN141XF-L05 (SAMSUNG)	LK.A0206.001
		LCD 15.0" TFT XG (AU)AB150XN01	LK.A0205.002
		LCD 15.0" TFT XGA HSD150PX11-B(HANNSTAR)	LK.A0207.001
	014-LCD 14.1" and LCD 15"	LCD INVERTER	19.A02V5.001
	009-LCD 14.1" and LCD 15"	LCD BRACKET L 14"	33.A02V5.007
		LCD BRACKET L 15" XGA	33.A02V5.009
		LCD BRACKET L15" SXGA+/UXGA	33.A02V5.011
		LCD BRACKET L15" SXGA+ HITACHI Note: The image is for L and R LCD brackets.	33.A02V5.013
	010-LCD 14.1" and LCD 15"	LCD BRACKET R 14"	33.A02V5.008
		LCD BRACKET R 15" XGA	33.A02V5.010
		LCD BRACKET R15" SXGA+/UXGA	33.A02V5.012
		LCD BRACKET R15" SXGA+ HITACHI Note: The image is for L and R LCD bracket.	33.A02V5.014









Picture	No.	Partname And Description	Part Number
	004-LCD 14.1" and LCD 15"	LCD PANEL WITH LOGO	60.A02V5.003
	005-LCD 14.1" and LCD 15"	LCD BEZEL WITH PRINTING-14.1"	60.A02V5.004
		LCD BEZEL WITH PRINTING-15.0"	60.A02V5.005
	006-LCD 14.1" and LCD 15"	COAXIAL CABLE 14.1" AU	50.A02V5.007
		COAXIAL CABLE 14.1" SAMSUNG	50.A02V5.008
		COAXIAL CABLE 15" XGA AU	50.A02V5.010
		COAXIAL CABLE 15"XGA HANNSTAR	50.A02V5.011
		COAXIAL CABLE 15" SXGA+ CPT	50.A02V5.012
		COAXIAL CABLE 15" SXGA+ HANNSTAR	50.A02V5.013
		COAXIAL CABLE 15" SXGA+ HITACHI	50.A02V5.014
		COAXIAL CABLE 15" UXGA IBM	50.A02V5.015
	NS	LCD HINGE ASSEMBLY (L&R)	6K.A02V5.001
PCMCIA Slot/PC Card slot			
	NS	PCMCIA SLOT	21.A02V5.001
FDD/Floppy Disk Drive			
	FDD ASSY	FDD MODULE, MITSUMI	6M.A02V5.011
		FDD MODULE, PANASONIC	6M.A02V5.012
		FDD 1.44MB SLIM MITSUMI/D353G-2938	HKF.0226.002
	001-FDD ASSY	FDD DRIVE PANASONIC	HKF.0226.001

Picture	No.	Partname And Description	Part Number
	002-FDD ASSY	FDD DOOR MITSUMI	42.A02V5.018
		FDD DOOR PANASONIC	42.A02V5.019
HDD/ Hard Disk Drive			
	NS	HDD 2.5 20G IBM CASCADE IC25N020ATCS04-0 07N8325 FW:A71A	KH.25202.001
Optical Drive			
	DVD ASSY	DVD-ROM MODULE 8X TOSHIBA	6M.A02V5.005
		DVD-ROM MODULE 8X MKE	6M.A02V5.006
		DVD-ROM MODULE 8X QSI	6M.A02V5.007
		DVD-RW COMBO MODULE TOSHIBA	6M.A02V5.008
		DVD-RW COMBO MODULE TEAC	6M.A02V5.010
	001-DVD ASSY (w/o optical lock on the exploded diagram	DVD-ROM 8X TOSHIBA SD-C2502	KV.00801.001
		DVD-ROM 8X MKE SR-8176	KV.00802.001
		DVD-ROM 8X QSI SDR-081	KV.00803.001
		DVD+RW COMBO 8X TOSHIBA/SDR21202	HKV.0210.001
		DVD+RW COMBO 8X TEAC/DW-28E-085	KO.00802.001
Cables			
	016-Logic Upper	FFC-LED 20 PIN (CABLE-FFC TOUCHPAD TO LED BOARD)	50.A02V5.001
	015-Logic Upper	FFC-TOUCHPAD (TOUCHPAD BOARD TO TOUCHPAD)	50.A02V5.002
	017-Logic Upper	FFC-LED 22 PIN (M/B TO TOUCHPAD BOARD)	50.A02V5.003

Picture	No.	Partname And Description	Part Number
	005-Logic Upper	FPC-FDD LF-1252(M/B TO TOUCHPAD BOARD)	50.A02V5.004
	004-FDD ASSY	FDD FPC MITSUMI	50.A02V5.005
		FDD FPC PANASONIC	50.A02V5.006
	NS	POWER CORD CONTINENTAL	27.A02V5.001
		POWER CORD DANISH	27.A02V5.002
		POWER CORD ITALIAN	27.A02V5.003
		POWER CORD PRC	27.A02V5.004
		POWER CORD SWISS	27.A02V5.005
		POWER CORD UK	27.A02V5.006
		POWER CORD US	27.A02V5.007
	003-HDD (W/O HDD) ASSY	HDD CONNECTOR	22.A02V5.002
Boards			
		POWER BOARD	55.A02V5.002
	252-Logic Upper	LED BOARD	55.A02V5.003
	253-Logic Upper	TOUCHPAD BOARD	56.A02V5.001

Picture	No.	Partname And Description	Part Number
	NS	MODEM CARD	54.A02V5.001
	NS	WIRELESS LAN CARD	54.A02V5.002
Adapter			
	NS	AS1400 90W DELTA ADAPTER(3-PIN)	AP.0201.001
		ADAPTER-API	AP.0201.002
Battery			
	NS	BATTERY LI-ION 12 CELL-SONY	BT.A0201.002
		BATTERY LI-ION 12 CELL-PANASONIC	BT.A0201.001
Keyboard			
	NS	AS1400 KEYBOARD CHICONY Arabic	KB.A0203.010
		AS1400 KEYBOARD CHICONY Belgium	KB.A0203.012
		AS1400 KEYBOARD CHICONY Traditional Chiese	KB.A0203.005
		AS1400 KEYBOARD CHICONY Czech	KB.A0203.014
		AS1400 KEYBOARD CHICONY Danish	KB.A0203.017
		AS1400 KEYBOARD CHICONY French	KB.A0203.006
		AS1400 KEYBOARD CHICONY German	KB.A0203.003
		AS1400 KEYBOARD CHICONY Hungaian	KB.A0203.015
		AS1400 KEYBOARD CHICONY Italian	KB.A0203.004
		AS1400 KEYBOARD CHICONY Norway	KB.A0203.016
		AS1400 KEYBOARD CHICONY Portuguese	KB.A0203.009
		AS1400 KEYBOARD CHICONY Spanish	KB.A0203.008
		AS1400 KEYBOARD CHICONY Sweden	KB.A0203.013
		AS1400 KEYBOARD CHICONY Swiss/G	KB.A0203.007

Picture	No.	Partname And Description	Part Number
		AS1400 KEYBOARD CHICONY Thai	KB.A0203.011
		AS1400 KEYBOARD CHICONY Turkish	KB.A0203.018
		AS1400 KEYBOARD CHICONY UK	KB.A0203.002
		AS1400 KEYBOARD CHICONY US	KB.A0203.001
Case/Cover/Bracket Assembly			
	NS	MIDDLE COVER	42.A02V5.001
	309-The System	DIMM COVER	42.A02V5.002
	NS	HEATSINK COVER	42.A02V5.003
	301-The System	LOWER CASE W/O SPEAKER-INCLUDING BATTER LATCH, NOB, SPRING	60.A02V5.001
	003-Logic Upper	UPPER CASE	60.A02V5.002
	001-Logic Upper	EMI SHIELDING	31.A02V5.001
	314-The System	OPTICAL BRACKET	33.A02V5.001

Picture	No.	Partname And Description	Part Number
	008-Logic Upper	TOUCHPAD BRACKET	33.A02V5.002
	311-The System	HEATSINK BRACKET	33.A02V5.003
	002-Logic Upper	LED BRACKET	33.A02V5.004
	310-The System	D-SUB BRACKET	33.A02V5.005
	312-The System	CPU SUPPORT BRACKET	33.A02V5.006
	006-Logic Upper	HINGE SADDLE-R Note: The image includes right and left hinge saddles.	34.A02V5.001
	007-Logic Upper	HINGE SADDLE-L Note: The image includes right and left hinge saddles.	34.A02V5.002
	NS	BATTERY LATCH	42.A02V5.004
	NS	BATTERY LATCH KNOB	V42.A02V5.005

Picture	No.	Partname And Description	Part Number
	NS	BATTERY LATCH SPRING	34.A02V5.003
	NS	ANTENNA COVER-R Note: The image includes the right and left antenna covers.	42.A02V5.006
	NS	ANTENNA COVER-L Note: The image includes the right and left antenna covers.	42.A02V5.007
	001-HDD (W/O HDD) ASSY	HDD CARRIER	42.A02V5.020
	005-HDD (W/O HDD) ASSY	HDD EMI PLATE	34.A02V5.004
	003-DVD ASSY	OPTICAL LOCK	22.A02V5.001
Others			
	001-The System	SPEAKER ASSY(R&L)	6K.A02V5.002
	018-Logic Upper	TOUCHPAD (BACK SIDE)	31.A02V5.002

Picture	No.	Partname And Description	Part Number
	313-The System	FAN	31.A02V5.003
	NS	HEATSINK	23.A02V5.001
	NS	ANTENNA LINE-L	50.A02V5.016
		ANTENNA LINE-R	50.A02V5.017
Screws			
	315-Logic Upper	SCREWLOCK, 6NUT	86.A02V5.001
		SCREW, M1.7X2.5L	86.A02V5.002
		SCREW, TPB 2.0X4	86.A02V5.003
		SCREW, M2.5X3	86.A02V5.004
	307-The System	SCREW, M2.5X4	86.A02V5.005
		SCREW, M2.5X8	86.A02V5.006
		SCREW, M2X3	86.A02V5.007
	308-The System	SCREW,M2X4	86.A02V5.008
		SCREW, M2X6	86.A02V5.009
	002-HDD ASSY	SCREW, M3X3	86.A02V5.010
		SCREW, TPB 1.7X3.5	86.A02V5.011

Model Definition and Configuration

Aspire 1400

1. Project Name: Compal project
2. Description

The Aspire 1400 employs Intel Pentium 4 processor with the reputable Intel 845 chipset that delivers a high performance and professional mobile PC. With powerful multi-media functions, Audio DJ controls and high quality display, it becomes a desktop replacement.

Main memory is expandable to 1024MB SDRAM¹. Powerful data storage with 1.44 MB floppy disk drive, one 20G or larger Ultra DMA-100 hard disk drive² and one internal optical drive. As to display, The Aspire 1400 integrates ATI MOBILITY RADEON graphics accelerator with 16MB of DDR video memory. In addition to 14.1/15.0 TFT color LCD supporting XGA resolution of 1024x769, 32-bits colors, Aspire 1400 also has 4x AGP support and is suitable LCD and CRT display plus DualView support. It has a hardware 3D graphics engine and an MPEG-2 DVD hardware-assisted capability. Audio ports for speaker/headphone-out jack and microphone/line-in jack devices provide the user the best compatibility as he plugs in other peripherals.

¹ 512MB soDIMM memory module

² Specifications vary depending on configuration.

Main Features

Processor & Core Logic

- Intel® Pentium® 4 from 1.7GHz with 256KB L2 cache, up to 2.4GHz with 512KB L2 cache
- Intel® 845 chipset supports 400MHz system bus
- Standard 128/256MB SDRAM, upgradeable to 1024MB
- ATI MOBILITY RADEONTM 4x AGP graphic controller with external 16MB DDR
- Simultaneous LCD and CRT display capability
- DualView® support
- Hardware 3D graphics engine
- MPEG-2/DVD hardware-assisted capability
- 20GB or larger Ultra DMA-100 HDD, 1.44 3.5" FDD and 8x DVD-ROM or 8x DVD/24x(8/8/24) CD-RW combo drive
- 87Wh Li-ion battery pack
- 3-hour battery life³; 9-hour charge-in-use
- Power management system
- Four Audio DJ music CD control buttons for play/pause, stop/eject, previous track, and next track
- Keyboard has international language support.

³ Actual battery life may be different because of the usage and configuration.

Test Compatible Components

This computer's compatibility is tested and verified by Acer's internal testing department. All of its system functions are tested under Windows XP environment.

Refer to the following lists for components, adapter cards, and peripherals which have passed these tests.

Regarding configuration, combination and test procedures, please refer to the TravelMate a-550 Compatibility Test Report released by the Acer Mobile System Testing Department.

Microsoft Windows XP Environment Test

Item	Specifications
Display	ViewSonic PS775 Phillips Brilliance 17"
Modem Adapters	
Modem	Xircom Modem WinGlobal CBM56WG
LAN	3Com10/100with XJACK connector 3 CXFE575CT LINKSYS Ethernet Card EC2T
Multi-Function	Xircom RealPort Ethernet 10/100+Modem 56RBE56G Xircom Ethernet 10/100+ Modem 56CBEM56
I/O Peripheral	
I/O - printer (parallel)	HP LaserJet 5P EPSON Stylus 740
I/O - TV	Sony KV-W32MX2
I/O - Keyboard	Chicony USB keyboard
I/O - USB	Belkin Express Bus F5U001 HUB IOMega USB 100ZIP
I/O - USB (Printer)	EPSON Stylus Color 740
I/O - USB (Mouse)	Logitech M-S35 Maxxtro MUS6U Microsoft Intel Mouse Explorer Power Ring Elastic PM4D
I/O - USB (Speaker)	Panasonic EAB-MPC57USB
I/O - USB (Camera)	Intel PC Camera Pro Pack
I/O - USB (ZIP)	IOMEGA ZIP100
I/O - USB (HUB)	BELKIN Express Bus 4Port USB HUB D-LINK DU-H4 USB HUB
I/O - USB (FDD)	TEAC YE-DATA
I/O Adapter	
PCMCIA - SCSI	Adaptec SlimSCSI APA-1460AB Adaptec SlimSCSI APA-1480
PCMCIA - ATA	IOMega Click! 40MB Toshiba Mobile HDD 5GB
PCMCIA - Flash Memory	Pretec Flash 8MB Pretec Flash 16MB
PCMCIA - CardBus Card	TDK Flyer 100 Base-TX LAK-CB-100AX 3Com 32 bit Base-TX 3C575-TX

Online Support Information

This section describes online technical support services available to help you repair your Acer Systems.

If you are a distributor, dealer, ASP or TPM, please refer your technical queries to your local Acer branch office. Acer Branch Offices and Regional Business Units may access our website. However some information sources will require a user i.d. and password. These can be obtained directly from Acer CSD Taiwan.

Acer's Website offers you convenient and valuable support resources whenever you need them.

In the Technical Information section you can download information on all of Acer's Notebook, Desktop and Server models including:

- Service guides for all models
- User's manuals
- Training materials
- Main manuals
- Bios updates
- Software utilities
- Schematics
- Spare parts lists
- Chips
- TABs (Technical Announcement Bulletin)

The service repair section provides you with downloadable information on:

- Troubleshooting guides
- Tooling box information
- Repair instructions for specific models
- Basic repair guidelines
- Debug cards for Acer's latest models

For these purposes, we have included an Acrobat File to facilitate the problem-free downloading of our technical material.

Also contained on this website are:

- Detailed information on Acer's International Traveler's Warranty (ITW)
- Returned material authorization procedures
- An overview of all the support services we offer, accompanied by a list of telephone, fax and email contacts for all your technical queries.

We are always looking for ways to optimize and improve our services, so if you have any suggestions or comments, please do not hesitate to communicate these to us.

A

- AC Adapter 33
- ACPI 1.0a 25
- AFLASH Utility 48
- Audio 28, 29

B

- Battery 30
- Battery Pack 59
- battery pack
 - charging indicator 15, 16
- BIOS 25
 - package 25
 - password control 25
 - ROM size 25
 - ROM type 25
 - vendor 25
 - Version 25
- BIOS Setup Utility 37
- BIOS Supports protocol 25
- BIOS Utility 37
 - Basic System Settings 40
 - Navigating 37
 - System Information 38
 - System Security 46, 47
- Board Layout
 - Bottom View 7
 - Top View 6

C

- Cache
 - controller 25
 - size 25
- caps lock
 - on indicator 16
- CardBus 29
- computer
 - on indicator 15
- Core logic 29
- CPU
 - core voltage 25
 - package 25
 - type 25

D**DIMM**

- Combinations 26
- external 60
- removing 60

Disassembly

- Battery Pack 58
- CD-ROM/DVD-ROM Module 62
- Floppy Disk Drive 66
- Machine 55
- Procedure Flowchart 57

Display 5**DVD-ROM Interface 27****E**

- Error Symptom-to-Spare Part Index 73
- External CD-ROM Drive Check 70
- External Diskette Drive Check 70

F

- Features 3
- features 105
- Flash Utility 48
- Floppy Disk
 - removing the 66
- Floppy Disk Drive Interface 26
- FRU (Field Replaceable Unit) List 87

H

- Hard disk 26, 29
- Hardware Specifications and Configurations 24
- HDD 26, 29
- Hot Keys 17

I

- Indicators 15
- Intermittent Problems 80

J

- Jumper and Connector Locations 83
 - Top View 83

K

- Keyboard 29
- Keyboard or Auxiliary Input Device Check 71

L

L2 cache 25
LAN/Modem Combo 26

M

Machine Disassembly 55
media access
 on indicator 15, 16
Memory Check 71
Model Definition 104
Modem 26
Modem Combo Card
 external 61

N

num lock
 on indicator 15, 16

O

Online Support Information 109

P

Panel 9
 Bottom 14
 left 9
 Rear 12
 right 12
Parallel Port 28
PC Card 15, 29
PCMCIA 29
Power System Check 71
 Battery Pack 72
Processor 25

R

RMA 87
RTC 29

S

Second Level Cache 25
Super I/O 29
System
 Block Diagram 5
System Check Procedures 70
System Diagnostic Diskette 48
System Memory 25
System Specifications
 Features 105

System Utilities 37
System Utility Diskette 48

T

Temperature 34
Test Compatible Components 107
Touchpad Check 72
Troubleshooting 69

U

Undetermined Problems 81
USB 29
utility
 BIOS 37

V

Video 28
 Resolutions 28
Video controller 29

W

Windows 2000 Environment Test 108